

JVC



ENGLISH

中文

ภาษาไทย

CD/CASSETTE RECEIVER

CD / 卡座收音組合機

เครื่องเล่นซีดี/เทปคลาสเซต

KW-XC777

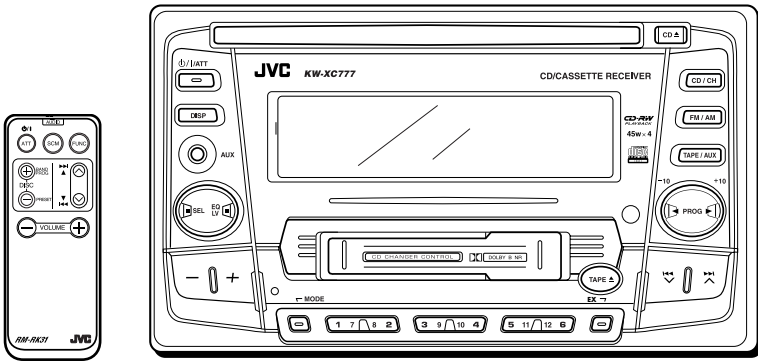

For installation and connections, refer to the separate manual.

有關安裝和連接方法，分別參閱操作手冊。

เพื่อการติดตั้งและการเชื่อมต่อ โปรดอ้างอิงคู่มือที่แยกมา

INSTRUCTIONS

使用說明書

คู่มือการใช้งาน

LVT0834-001A
[U]

IMPORTANT FOR LASER PRODUCTS

Precautions:

1. CLASS 1 LASER PRODUCT
2. **CAUTION:** Invisible laser radiation when open and interlock failed or defeated. Avoid direct exposure to beam.
3. **CAUTION:** Do not open the top cover. There are no user-serviceable parts inside. Leave all servicing to qualified service personnel.
4. **CAUTION:** This CD player uses invisible laser radiation, however, is equipped with safety switches to prevent radiation emission when unloading CDs. It is dangerous to defeat the safety switches.
5. **CAUTION:** Use of controls, adjustments or performance of procedures other than those specified herein may result in hazardous radiation exposure.

About the demonstration mode (DEMO MODE)...

When shipped from the factory, "DEMO" is set to "DEMO ON" in this unit. The demonstration will start automatically if no sound comes in for 3 minutes. (See page 25.)

To deactivate the demonstration mode

- 1 Press and hold SEL for more than 2 seconds so that one of the PSM items appears on the display.
- 2 Press ►►|▲ or |◄◄▼ to select "DEMO."
- 3 Press – to select "DEMO OFF"
- 4 Press SEL (Select) to finish the setting.

CAUTION on Volume Setting

CDs produce very little noise compared with other sources. If the volume level is adjusted for the tuner, for example, the speakers may be damaged by the sudden increase in the output level. Therefore, lower the volume before playing a CD and adjust it as required during playback.

How to reset your unit

Press the reset button on the front panel using a ball-point pen or similar tool.

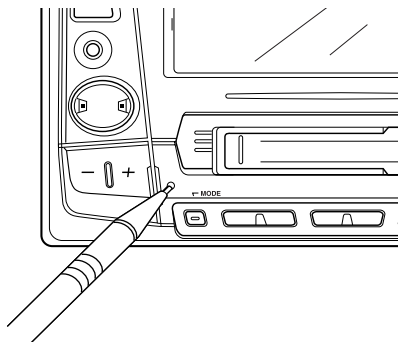

Note:

Your preset adjustments – such as preset channels or sound adjustments – will be erased.

Thank you for purchasing a JVC product. Please read all instructions carefully before operation, to ensure your complete understanding and to obtain the best possible performance from the unit.

CONTENTS

About the demonstration mode (DEMO MODE)	2	SOUND ADJUSTMENTS	18
How to reset your unit	2	Adjusting the sound	18
LOCATION OF THE BUTTONS	4	Reinforcing the bass sound	18
Control panel	4	Selecting preset sound modes	19
Remote controller	5	Storing your own sound adjustments	20
Preparing the remote controller	6	LEVEL METER SETTING	21
BASIC OPERATIONS	7	Selecting level meter patterns	21
RADIO OPERATIONS	8	Level meter patterns	21
Listening to the radio	8	OTHER MAIN FUNCTIONS	22
Storing stations in memory	9	Setting the clock	22
Automatic preset: SSM	9	Changing general settings (PSM)	22
Manual preset	9	Assigning names to the sources	25
Storing your favorite station into the EX (extra) button	10	EXTERNAL COMPONENT OPERATIONS ...	27
Tuning in to a preset station	10	CD CHANGER OPERATIONS	28
Other convenient tuner functions	11	Playing CDs	28
Scanning broadcast stations	11	Selecting CD playback modes	30
Showing a station name	11	MAINTENANCE	31
Selecting FM reception mode	11	Handling cassettes	31
CD OPERATIONS	12	Handling CDs	32
Playing a CD	12	TROUBLESHOOTING	33
Playing a CD Text	13	SPECIFICATIONS	35
Locating a track or a particular portion on a CD	13		
Selecting CD playback modes	14		
Prohibiting CD ejection	14		
TAPE OPERATIONS	15		
Listening to a tape	15		
Finding the beginning of a tune	16		
Other convenient tape operations	17		
Skipping blank portions on the tape	17		
Playing the current tune repeatedly	17		
Prohibiting tape ejection	17		

BEFORE USE

*For safety....

- Do not raise the volume level too much, as this will block outside sounds, making driving dangerous.
- Stop the car before performing any complicated operations.

*Temperature inside the car....

If you have parked the car for a long time in hot or cold weather, wait until the temperature in the car becomes normal before operating the unit.



LOCATION OF THE BUTTONS

ENGLISH

Control panel

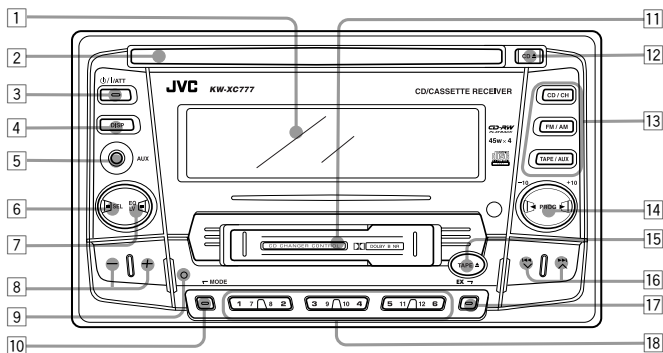

Display window

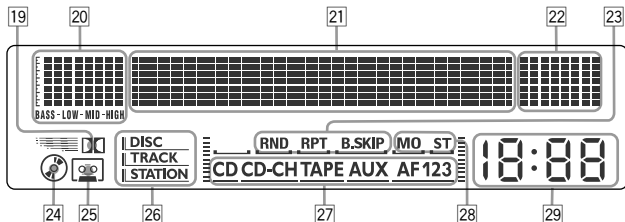

Control panel

- 1 Display window
- 2 CD loading slot
- 3 **⏻/ATT** (standby/on / attenuator) button
- 4 DISP (display) button
- 5 Auxiliary input jack
- 6 SEL (select) button
- 7 EQ LV (Equalizer/Level) button
- 8 + / - buttons
- 9 Reset button
- 10 MODE button
- 11 Cassette compartment
- 12 CD **▲** (eject) button
- 13 Source buttons
 - CD/CH button
 - FM/AM button
 - TAPE/AUX button
- 14 **◀** PROG **▶** button
 - +10 / -10 button
- 15 TAPE **▲** (eject) button
- 16 **◀◀** **▶▶** / **▶▶** **▲** buttons
- 17 EX (extra) button
- 18 Number buttons

Display window

- 19 Dolby NR indicator
- 20 EQ level indicator/S.BASS (Super Bass) level/level meter
- 21 Main display
- 22 Level meter
- 23 Play mode indicators
RND (random), RPT (repeat),
B.SKIP (blank skip)
- 24 CD indicator
- 25 TAPE indicator
- 26 Text name indicators
DISC, TRACK, STATION
- 27 Source indicators
CD, CD-CH (CD-changer), TAPE, AUX, F1, F2,
F3, A
- 28 Tuner reception indicators
MO (monaural), ST (stereo)
- 29 Clock display



Remote controller

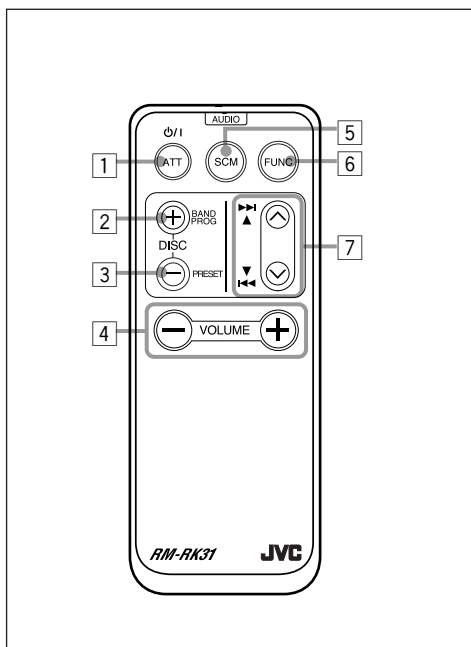

1 Functions the same as the ⏻ / ATT button on the main unit.

2

- Changes the band while listening to the radio.
- Changes the tape direction while listening to a tape.
- Selects disc numbers in the increasing order, and starts playing while listening to the CD changer.

3

- Selects preset numbers in the increasing order while listening to the radio.
- Selects disc numbers in the decreasing order, and starts playing while listening to the CD changer.

4 Functions the same as the +/- buttons on the main unit.

Note:

This button does not function for the preferred setting mode (PSM) adjustment.

5 Selects the sound mode.
Each time you press button, the EQ (equalizer) mode changes.

6 Selects the source.
Each time you press FUNC (function), the source changes.

7

- Searches stations while listening to the radio.
- Fast-forwards or reverses the track if pressed and held while listening to a CD.
- Skips to the beginning of the next tracks or goes back to the beginning of the current (or previous) tracks if pressed briefly while listening to a CD.
- Fast-forwards or rewinds a tape and find a beginning of a tune (MMS) while listening to a tape.
- Does not function as \blacktriangle / \blacktriangledown buttons.

Preparing the remote controller

Before using the remote controller:

- Aim the remote controller directly at the remote sensor on the main unit. Make sure there is no obstacle in between.
- Do not expose the remote sensor to strong light (direct sunlight or artificial lighting).

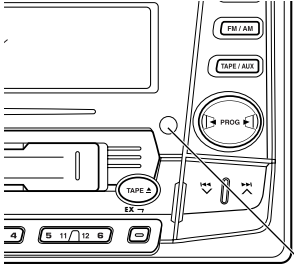

Remote sensor

Installing the battery

When the controllable range or effectiveness of the remote controller decreases, replace the battery.

1. Remove the battery holder.

- 1) Push out the battery holder in the direction indicated by the arrow using a ball-point pen or a similar tool.
- 2) Remove the battery holder.

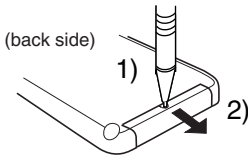

2. Place the battery.

Slide the battery into the holder with the + side facing upwards so that the battery is fixed in the holder.

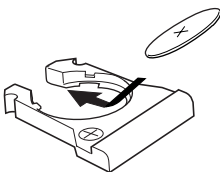

Lithium coin battery
(product number:
CR2025)

3. Return the battery holder.

Insert again the battery holder pushing it until you hear a clicking sound.

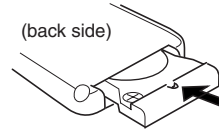

WARNING:

- Store the battery in a place where children cannot reach.
If a child accidentally swallows the battery, consult a doctor immediately.
- Do not recharge, short, disassemble or heat the battery or dispose it in a fire.
Doing any of these things may cause the battery to give off heat, crack or start a fire.
- Do not leave the battery with other metallic materials.
Doing this may cause the battery to give off heat, crack or start a fire.
- When throwing away or saving the battery, wrap it in tape and insulate; otherwise, the battery may start to give off heat, crack or start a fire.
- Do not poke the battery with tweezers or similar tools.
Doing this may cause the battery to give off heat, crack or start a fire.

CAUTION:

DO NOT leave the remote controller in a place (such as dashboards) exposed to direct sunlight for a long time.

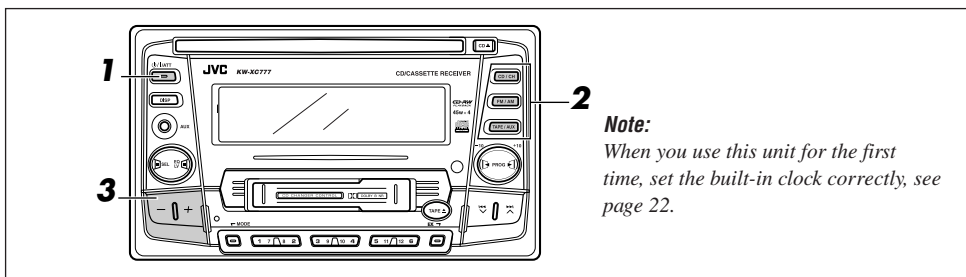

Note:
When you use this unit for the first time, set the built-in clock correctly, see page 22.

1 Turn on the power.

/ I / ATT “HELLO!” appears on the display.

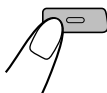

Note on One-Touch Operation:

When you select a source in step 2 below, the power automatically comes on. You do not have to press this button to turn on the power.

2 Select the source.

CD / CH

- Each time you press CD/CH, the source changes to CD* and CD-changer (or external component)** alternately.

FM / AM

- Each time you press FM/AM, the band changes to FM (FM1, FM2, FM3) and AM.

TAPE / AUX

- Each time you press TAPE/AUX, the source changes to TAPE*** and external component (AUX INPUT) alternately.

* If a CD is not in the loading slot, you cannot select CD as the source to play. (“NO DISC” will appear on the display.)

** Without connecting the CD changer or the external component, you cannot select it as the source to play.

*** If a cassette is not in the cassette compartment, you cannot select TAPE as the source to play. (“NO TAPE” will appear on the display.)

To operate the tuner, see pages 8 – 11.

To operate the CD player, see pages 12 – 14.

To operate the tape deck, see pages 15 – 17.

To operate the external components, see page 27.

To operate the CD changer, see pages 28 – 30.

3 Adjust the volume.

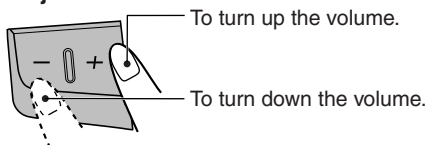

4 Adjust the sound as you want (see pages 18 – 20).

- If you need to change the level meter pattern, see page 21.

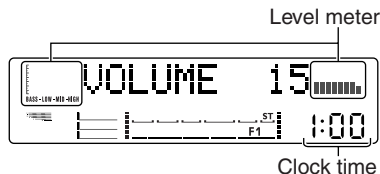

To drop the volume in a moment

Press / I / ATT briefly while listening to any source. “ATT” starts flashing on the display, and the volume level will drop in a moment. To resume the previous volume level, press the button briefly again.

To turn off the power

Press / I / ATT for more than 1 second. “SEE YOU” appears, then the unit turns off.

- If you turn off the ignition key without turning off this unit, the unit will automatically turn on when you turn on the ignition key next time. If the last selected source is ready for playback (ex. a CD or a tape is in the unit), playback starts automatically.



RADIO OPERATIONS

ENGLISH

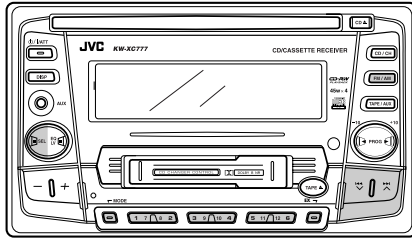

Listening to the radio

You can use either automatic searching or manual searching to tune in to a particular station.

Searching a station automatically: Auto search

- 1 Select the band (FM1, FM2, FM3 or AM).

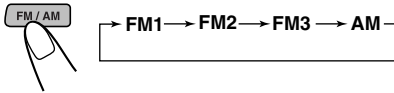

Note:

This receiver has three FM bands (FM1, FM2, and FM3). You can use any one of them to listen to an FM broadcast.

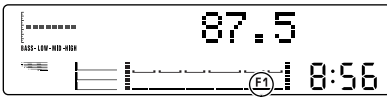

Selected band appears.

- 2 Start searching a station.

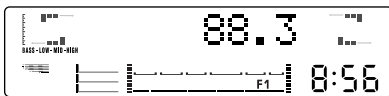
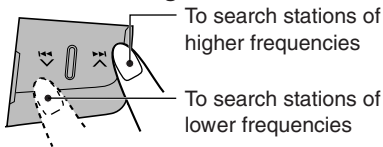

When a station is received, searching stops.

To stop searching before a station is received, press the same button you have pressed for searching.

Searching a station manually: Manual search

- 1 Select the band (FM1, FM2, FM3, or AM).



- 2 Press and hold $\blacktriangleright\blacktriangle$ \blacktriangle or $\blacktriangleleft\blacktriangledown$ until "M (manual)" starts flashing on the display.

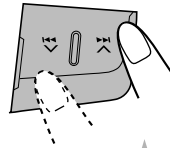

- 3 Tune in to a station you want while "M" is flashing.

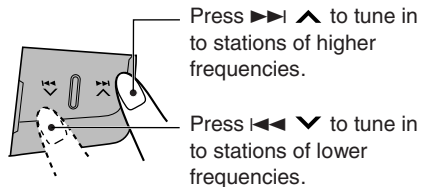

- If you release your finger from the button, the manual mode will automatically turn off after 5 seconds.
- If you hold down the button, the frequency keeps changing (in 50 kHz intervals for FM and 9 kHz for AM) until you release the button.

Storing stations in memory

You can use one of the following methods to store broadcasting stations in memory.

- Automatic preset: SSM (Strong-station Sequential Memory)
- Manual preset
- Storing your favorite station into the EX button

Automatic preset: SSM

You can preset 6 local stations in each FM band (FM1, FM2, and FM3).

1 Select the band (FM1, FM2, or FM3).

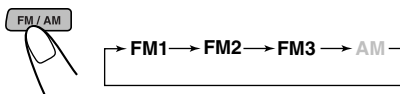

2 Press MODE repeatedly until “SSM” appears.

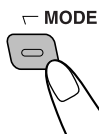

3 Press SEL.



“--SSM--” appears, then disappears when automatic preset is over.

Local stations with the strongest signals are searched and stored automatically in the band you have selected (FM1, FM2, and FM3). These stations are preset in the number buttons — No. 1 (lowest frequency) to No. 6 (highest frequency). When automatic preset is over, the station stored in number button 1 will be automatically tuned in.

Manual preset

You can preset up to 6 stations in each band (FM1, FM2, FM3, and AM) manually.

EXAMPLE: Storing an FM station of 88.3 MHz into the preset channel number 1 of the FM1 band

1 Select the FM1 band.



2 Tune in to a station (in this example, of 88.3 MHz).

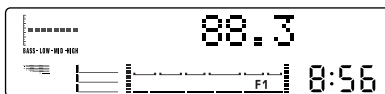
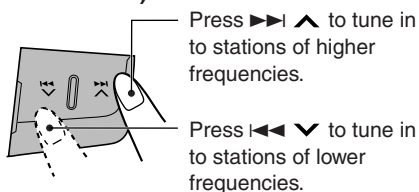

3 Press and hold the number button (in this example, 1) for more than 2 seconds.

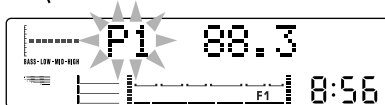
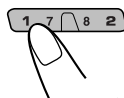

“P1” flashes for a few seconds.

4 Repeat the above procedure to store other stations into other preset numbers.



Storing your favorite station into the EX (extra) button

You can preset an FM or AM station (such as your favorite station or traffic announcement station); and recall it by one touch operation even if the unit is turned off.

EXAMPLE: Storing an FM station of 88.3 MHz into the EX button

1 Select the FM1 band.



2 Tune in to a station (in this example, of 88.3 MHz.)

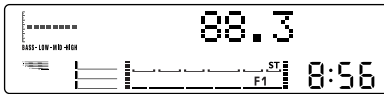
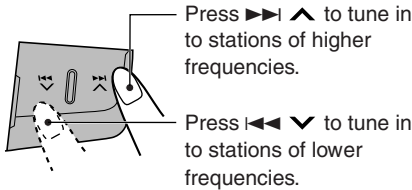

3 Press and hold the EX button until "EX" flashes.

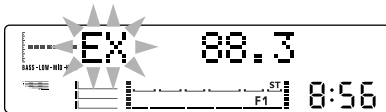

"EX" flashes on the display.

Notes:

- A previously preset station is erased when a new station is stored.
- Preset stations are erased when the power supply to the memory circuit is interrupted (for example, during battery replacement). If this occurs, preset the stations again.

Tuning in to a preset station

You can easily tune in to a preset station. Remember that you must store stations first. If you have not stored them yet, see page 9.

1 Select the band (FM1, FM2, FM3, or AM) you want.



2 Select the number (1 - 6) for the preset station you want.

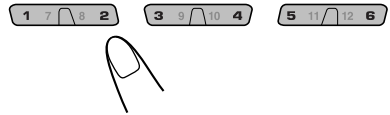

To tune in the favorite station (EX)



Press EX so that the unit automatically turns on (if it has been off). Your favorite station is tuned in.

- If you press the button again, the previous source will be played back again.

Other convenient tuner functions

Scanning broadcast stations

1 Select "SCAN".

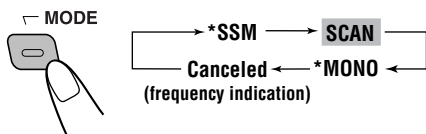

* When receiving an FM stereo broadcast.

2 Start scanning.

Each time a broadcast is tuned in, scanning stops for about 5 seconds (tuned frequency number flashes on the display), and you can check what program is now being broadcasted.



If you want to listen to that program, press MODE button again to stop scanning.

Selecting FM reception mode

When an FM stereo broadcast is hard to receive, follow the procedure below:

1 Select "MONO".

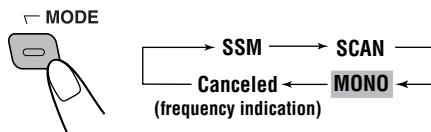

2 Select FM reception mode.

FM reception mode turns on ("MONO ON") and off ("MONO OFF") alternately.



When the monaural mode is turned on, the sound you hear becomes monaural but reception will be improved.

Showing a station name

If you have assigned a name to a station frequency, the display shows its assigned name after the station frequency is displayed. When the station name is displayed, the STATION indicator lights up on the display (see page 25).

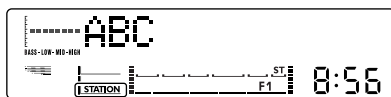

Lights up.

To confirm the station frequency while the assigned name is shown, press DISP (display). Each time you press the button, the assigned name and the station frequency alternate on the display.

Note:

If no name is assigned, "NO NAME" will appear when you press DISP.



Lights up when receiving an FM broadcast in stereo.





CD OPERATIONS

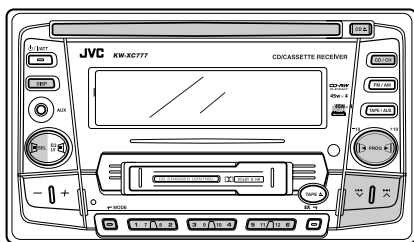

Playing a CD

1 Insert a disc into the loading slot.

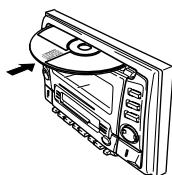

The unit turns on, draws a CD and starts playback automatically.

Notes:

- When a CD is inserted upside down, the CD automatically ejects.
- When you play a CD Text, the disc title and performer appear on the display. Then the current track title appears on the display, followed by the track number and elapsed playing time. See also "Playing a CD Text" (page 13) and "Selecting the scroll mode – SCROLL" (page 24).
If a CD Text includes much text information, some may not appear on the display.

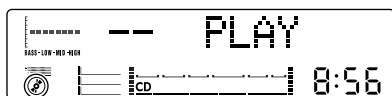

CD indicator lights up.

Total track number of the inserted disc Total playing time of the inserted disc



Current track Elapsed playing time



To stop play and eject the CD

Press CD ▲.

CD play stops and the CD automatically ejects from the loading slot ("EJECT" appears on the display). The source changes to the last selected source.

If you change the source, the CD play also stops (without ejecting the CD this time).

Notes:

- If the ejected disc is not removed for about 15 seconds, the disc is automatically inserted again into the loading slot to protect it from dust. (CD play will not start this time.)
- You can eject the CD even when the unit is turned off.

Note on One-Touch Operation:

When a CD is already in the loading slot, pressing CD/CH turns on the unit and starts playback automatically.



Playing a CD Text

In a CD Text, some information about the disc (its disc title, performer and track title) is recorded. You can show these disc information on the display.

1 Select text display mode while playing a CD Text.

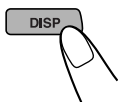

Each time you press the button, the display changes as follows:



When disc information appears on the display, the corresponding name indicator lights up.

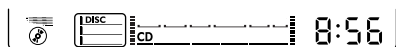

When a disc title/performer is displayed.

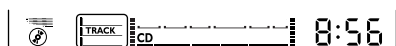

When a track title is displayed.

Notes:

- You can use the scroll mode to show the disc information on the display. See also "Selecting the scroll mode – SCROLL" on page 24.
- When you press DISP (display) while playing a conventional CD, "NO NAME" appears for the disc title/performer and the track title.

Locating a track or a particular portion on a CD

To fast-forward or reverse the track

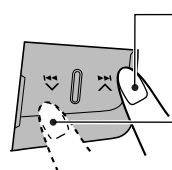

Press and hold **▶▶▶ ▲** while playing a CD, to fast-forward the track.

Press and hold **◀◀◀ ▼** while playing a CD, to reverse the track.

To go to the next tracks or the previous tracks

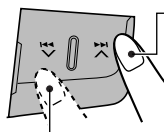

Press **▶▶▶ ▲** briefly while playing a CD, to go ahead to the beginning of the next track. Each time you press the button consecutively, the beginning of the next tracks is located and played back.

Press **◀◀◀ ▼** briefly while playing a CD, to go back to the beginning of the current track. Each time you press the button consecutively, the beginning of the previous tracks is located and played back.

To skip 10 tracks

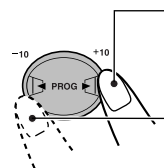

Press **+10** while playing a CD, to skip 10 tracks at a time.

Press **-10** while playing a CD, to skip back 10 tracks at a time.

To go to a particular track directly

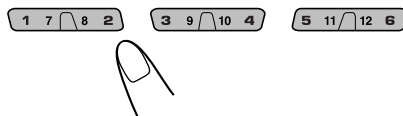

Press the number button corresponding to the track number to start its playback.

- To select a track number from 1 – 6:
Press 1 (7) – 6 (12) briefly.
- To select a track number from 7 – 12:
Press and hold 1 (7) – 6 (12) for more than 1 second.



Selecting CD playback modes

To play back tracks repeatedly (Repeat Play)

You can play back the current track repeatedly.

1 Press MODE repeatedly until "REPEAT" appears.

2 Press SEL. Each time you press the button, CD repeat play mode turns on ("REPEAT ON") and off ("REPEAT OFF") alternately.



When the repeat mode is turned on, the RPT indicator lights up on the display.

To play back tracks at random (Random Play)

You can play back all tracks on the CD at random.

1 Press MODE repeatedly until "RANDOM" appears.

2 Press SEL. Each time you press button, CD random play mode turns on ("RANDOM ON") and off ("RANDOM OFF") alternately.

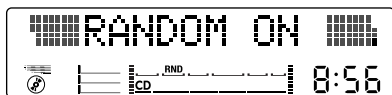

When the random mode is turned on, the RND indicator lights up on the display and a track randomly selected starts playing.

To play back only intro (Intro scan)

You can play back the first 15 seconds of each track sequentially.

1 Press MODE repeatedly until "INTRO" appears.

2 Press SEL. Each time you press button, CD Intro scan mode turns on ("INTRO ON") and off ("INTRO OFF") alternately.

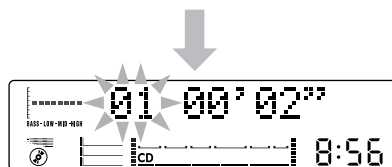

When the Intro scan mode is turned on, the current track number flashes.

Prohibiting CD ejection

You can prohibit the CD ejection and can "lock" a CD in the loading slot.

While pressing CD/CH, press and hold CD for more than 2 seconds. "CD

flashes on the display for a while, and the CD is locked and cannot be ejected.

To cancel the prohibition and "unlock" the CD, press and hold CD for more than 2 seconds again, while pressing CD/CH. "EJECT OK" flashes on the display for a while, and the CD is "unlocked."

TAPE OPERATIONS

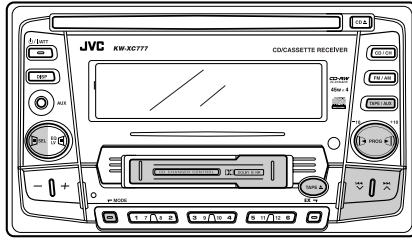

Listening to a tape

You can play back type 1 (normal) tapes.

- 1 Insert a cassette into the cassette compartment.**

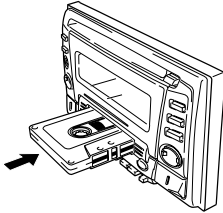

The unit turns on and tape play starts automatically.

When one side of the tape reaches its end during play, the other side of the tape automatically starts playing. (Auto Reverse)



Tape indicator flashes.

Note on One-Touch Operation:

When a cassette is already in the cassette compartment, pressing TAPE/AUX turns on the unit and starts tape play automatically.

- 2 Turn on or off the Dolby B NR* as needed.**

MODE 1 Press MODE repeatedly until "DOLBY B" appears.

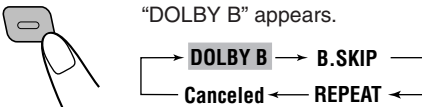

- 2 Press SEL.**



Each time you press the button, the Dolby B NR turns on ("DOLBY ON") and off ("DOLBY OFF").

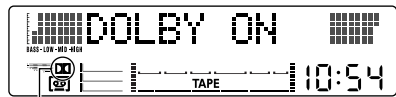

This indicator lights up when the Dolby B NR is turned on.

- 3 Select the tape direction.**



Each time you press the button, the tape direction changes alternately.

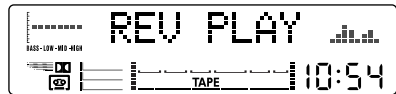

* Manufactured under license from Dolby Laboratories.
"Dolby" and the double-D symbol are trademarks of Dolby Laboratories.

To stop play and eject the cassette

Press TAPE ▲.

Tape play stops and the cassette automatically ejects from the cassette compartment.

If you change the source, the tape play also stops (without ejecting the cassette this time).

- You can also eject the cassette by pressing TAPE ▲ with the unit turned off.

To fast-forward and rewind a tape

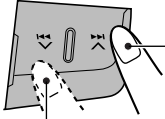

Press ►►| ▲ for more than 1 second to fast-forward the tape. When the tape reaches its end, the tape is reversed and playback starts from the beginning of the other side.

Press |◀◀ ▼ for more than 1 second to rewind the tape. When the tape reaches its end, playback of the same side starts.

To stop fast-forward and rewind at any position on the tape, press ◀ PROG ▶.

Tape play starts from that position on the tape.

Note:

When the tape reaches its end while fast-forwarding, the tape direction will be changed automatically.

Finding the beginning of a tune

Multi Music Scan allows you to automatically start playback from the beginning of a specified tune. You can specify up to 9 tunes ahead or before the current tune.

During playback

1 Specify where (how many tunes ahead or before the current tune) the tune you want is located.

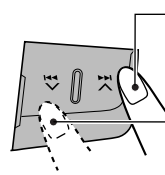

To locate a tune ahead of the current tune on the tape.

To locate a tune before the current tune on the tape.

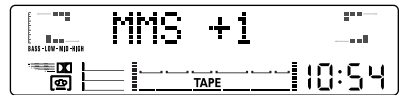

Each time you press the button, the number changes up to ± 9 .

When the beginning of the specified tune is located, playback starts automatically.

Notes:

- While locating a specified tune:
 - If the tape is rewound to its beginning, playback starts from the beginning of that side.
 - If the tape is fast-forwarded to the end, it is reversed and played from the beginning of the other side.
- In the following cases, Multi Music Scan may not operate correctly.
 - Tapes with tunes having long pianissimo passages (very quiet parts) or non-recorded portions during tunes.
 - Tapes with short non-recorded sections.
 - Tapes with high level noise or humming between tunes.
 - The Dolby NR setting does not match. For example, if the tape is recorded with the Dolby C NR.



Other convenient tape operations

Skipping blank portions on the tape

You can skip blank portions between the tunes (Blank Skip).

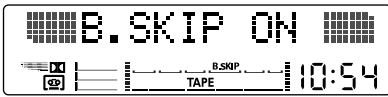
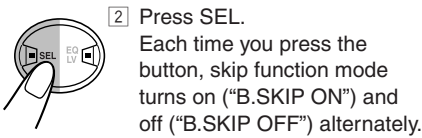
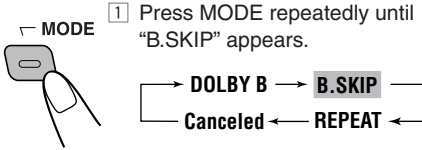

When this function is on, the B.SKIP indicator lights up on the display and the unit skips blank portions of 15 seconds or more, fast-forwards to the next tune, then starts playing it.

Playing the current tune repeatedly

You can play the current tune repeatedly (Repeat Play).

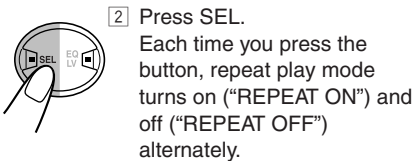
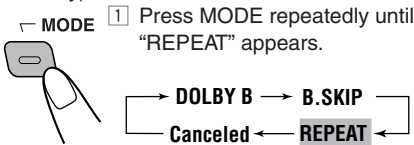

Notes:

In the following cases, Blank Skip and Repeat Play may not operate correctly.

- Tapes with tunes having long pianissimo passages (very quiet parts) or non-recorded portions during tunes.
- Tapes with short non-recorded sections.
- Tapes with high level noise or humming between tunes.
- The Dolby NR setting does not match. For example, if the tape is recorded with the Dolby C NR.

Prohibiting tape ejection

You can prohibit the tape ejection and can "lock" a tape in the cassette compartment.

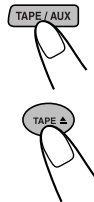

While pressing TAPE/AUX, press and hold TAPE ▲ for more than 2 seconds. "TAPE ▲" flashes on the display for a while, and the tape is locked and cannot be ejected.

To cancel the prohibition and "unlock" the tape, press and hold TAPE ▲ for more than 2 seconds again, while pressing TAPE/AUX.

"EJECT OK" flashes on the display for a while, and the tape is "unlocked."



SOUND ADJUSTMENTS

ENGLISH

Adjusting the sound

You can adjust the sound characteristics to your preference.

1 Select the item you want to adjust.



Each time you press the button, the adjustable items change as follows:



Indication	To do:	Range
FADER*	Adjust the front and rear speaker	R06 (rear only) F06 (front only)
BAL (Balance)	Adjust the left and right speakers	L06 (left only) R06 (right only)
VOLUME	Adjust the volume	00 (min.) 50 (max.)

* If you are using a two-speaker system, set the fader level to "00."

2 Adjust the level.

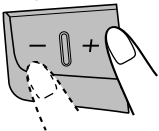

Note:

Normally + / - buttons work for volume adjustment. So you do not have to select "VOLUME" to adjust the volume level.

Reinforcing the bass sound

You can also adjust the level of Super Bass.

1 Select "S.BASS."

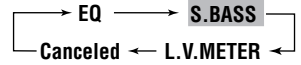

While adjusting Super Bass, the BASS indicator flashes.



As the number increases, Super Bass level also increases.

2 Adjust the level within the range of "00" to "08."

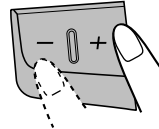



Selecting preset sound modes

You can select a preset sound adjustment suitable to the music genre.

1 Select "EQ."

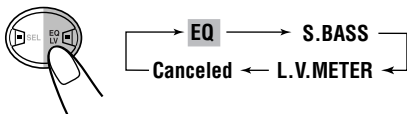

2 Select the sound mode.

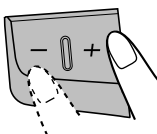

The sound mode changes as follows:

FLAT	↔	Hard Rock	↔	R & B*	↔
POP	↔	JAZZ	↔	DanceMusic	↔
Country	↔	Raggae	↔	Classic	↔
USER**	↔	(back to the beginning)			

* *Rhythm and Blues*

** *If you want to adjust and store your original sound mode (USER), see "Storing your own sound adjustments" on page 20.*

EQ level changes as you select the sound mode.

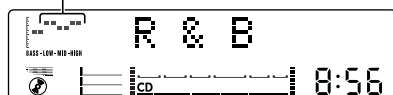

Ex.: When you select "R & B"

To cancel the sound mode, select "FLAT" in step 2.

Note:

You can adjust the sound mode to your preference, and store it in memory.

To store a sound mode separately for each playback source (EQ Link)

Once you select a sound mode, it is stored in memory. It will be recalled every time you select the same source. A sound mode can be stored for each of the following sources — FM1, FM2, FM3, AM, CD, tape, external components and the EX (extra) button (see page 10).

- See also "Changing general settings (PSM)" on page 22.

1 Press and hold SEL (select) for more than 2 seconds so that one of the PSM items appears on the display.

2 Press ►►▲ or ◀◀▼ to select "EQ LINK (Equalization Link)."

3 Press + to select "LINK ON."

4 Press SEL (select) to finish the setting.

To cancel EQ Link, repeat the same procedure and select "LINK OFF" by pressing – in step 3.

• When "EQ LINK" is set to "LINK ON"

The selected sound mode and Super Bass level can be stored in memory for the current source.

Each time you select the same source, the same sound mode is also recalled, and shown after the source name.

• When "EQ LINK" is set to "LINK OFF"

The selected sound mode effect applies to all the sources selected.



Storing your own sound adjustments

You can adjust the sound modes to your preference and store your own adjustments in memory (USER sound mode).

- There is a time limit in doing the following procedure. If the setting is cancelled before you finish, start from step 1 again.

1 Select "EQ."

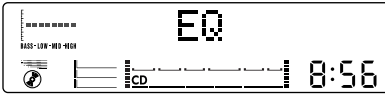
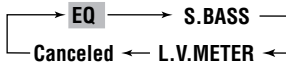

2 Select sound elements to adjust.



Each time you press the button, the sound elements to adjust change as follows:

- LOW FREQ.* → LOW LEVEL →
- MID FREQ.* → MID LEVEL →
- HIGH FREQ.* → HIGH LEVEL →
- (back to the beginning)

FREQ. (LOW, MID, HIGH):

Select the center frequency to adjust.

LEVEL (LOW, MID, HIGH):

Adjust the enhancement level.

* By pressing ►►| ▲ or ◀◀| ▼, you can directly move as follows:

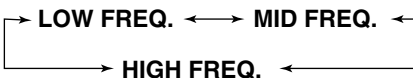

3 Adjust the selected sound element.

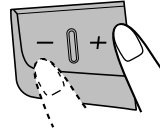

- Refer to the table below for adjusting the selected sound element.

Indication	Range
LOW FREQ.	50 Hz , 80 Hz , 120 Hz
LOW LEVEL	-06 (min.) — +06 (max.)
MID FREQ.	700 Hz , 1 kHz , 2 kHz
MID LEVEL	-06 (min.) — +06 (max.)
HIGH FREQ.	8 kHz , 12 kHz
HIGH LEVEL	-06 (min.) — +06 (max.)

EQ level adjusted flashes.

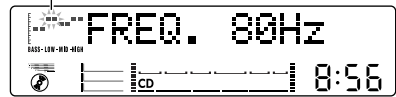

EX.: When you adjust "LOW FREQ."

4 Repeat step 2 and 3 to adjust the other sound elements.

5 Store the adjustments.



Your setting is stored in USER sound mode.

LEVEL METER SETTING



Selecting level meter patterns

You can select any one from 7 different level meter patterns or a demonstration of all the patterns.

1 Select "L.V. METER."

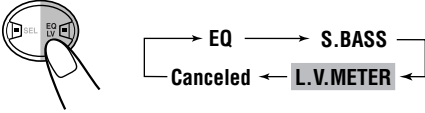

2 Press +/- to select the level meter pattern.

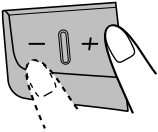

Each time you press the button, the level meter changes as follows:

- ALL DEMO ↔ Standard ↔ SideWinder ↔
 Full Size ↔ Spin ↔ Double ↔ HIGH WAY ↔
 Dolphin ↔ OFF ↔ (back to the beginning)

Level meter patterns

1. ALL DEMO (default setting)

Demonstrates all the level meter patterns, each for 20 seconds.

2. Standard

Standard level meter.



3. SideWinder

Level meter is displayed horizontally.



4. Full Size

Level meter is displayed on the main display.

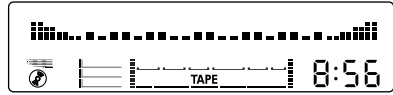

5. Spin

Spin in the right meter.



6. Double

Waves is displayed on both level meters.



7. HIGH WAY

As if you were driving along a highway.

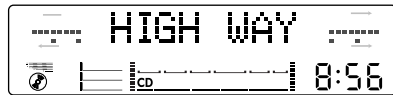

8. Dolphin

A dolphin is swimming in the main display.



9. OFF

No level meter is displayed.

Setting the clock

After installation, set the built-in clock correctly.

- 1 Press and hold SEL (select) for more than 2 seconds so that one of the PSM items appears on the display. (See page 23.)



- 2 If "CLOCK HOUR" does not appear, press ►►► ▲ or ◀◀◀ ▼ repeatedly until it appears.

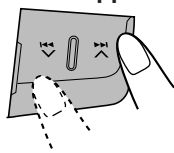

- 3 Adjust the hour.

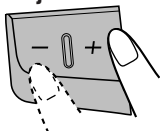

- 4 Press ►►► ▲ or ◀◀◀ ▼ until "CLOCK MIN (minute)" appears on the display.

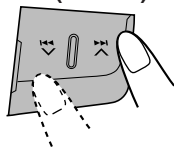

- 5 Adjust the minute.

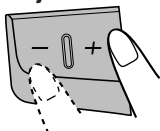

- 6 Finish the setting.



To check the current clock time while the unit is turned off, press DISP (display). The power turns on, the clock time is shown for 5 seconds, then the power turns off.

Changing general settings (PSM)

You can change the following settings for this unit by using the PSM (Preferred Setting Mode) control.

Basic Procedure

- There is a time limit in doing the following procedure. If the setting is canceled before you finish, start from step 1 again.

- 1 Press and hold SEL (select) for more than 2 seconds so that one of the PSM items appears on the display. (See page 23.)



- 2 Select a PSM item you want to adjust. (See page 23.)

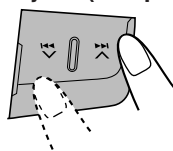

- 3 Adjust the PSM item selected.

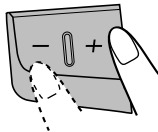

- 4 Repeat steps 2 and 3 to adjust the other PSM items if necessary.

- 5 Finish the setting.

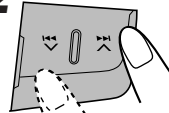
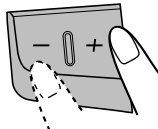

Preferred Setting Mode (PSM) items

1  Hold.		2  Select.		3  Set.		Factory-preset Settings	See page
		-	+				
CLOCK HOUR	Hour adjustment	Back	Advance	1:00	22		
CLOCK MIN	Minute adjustment	Back	Advance				
CLOCK DISP	Clock display	CLOCK OFF	CLOCK ON	CLOCK OFF	24		
EQ LINK	Sound control memory linkage	LINK ON	LINK OFF	LINK OFF	19		
DIMMER	Dimmer mode	DIM OFF ↔ DIM ON ↗ DIM AUTO ↖		DIM AUTO	24		
CONTRAST	Display contrast	CONTRAST 1 – CONTRAST 10		CONTRAST 5	24		
SCROLL	Scroll mode	SCRL ONCE ↔ SCRL AUTO ↗ SCRL OFF ↖		SCRL ONCE	24		
EXT INPUT	External input selection	CD CHANGER	LINE INPUT	CD CHANGER	24		
AUX ADJ	Auxiliary input level adjustment	A.ADJ 00 – A.ADJ 05		A.ADJ 00	24		
DEMO	Demonstration mode	DEMO OFF	DEMO ON	DEMO ON	25		

Setting the clock display – CLOCK DISP

You can set the clock to be shown on the display when the unit is turned off.

When shipped from the factory, the clock is set not to be shown on the display.

- **CLOCK OFF:** Clock display is turned off.
- **CLOCK ON:** Clock display is turned on.

Note:

If the power supply is not interrupted by turning off the ignition key of your car, it is recommended to select “CLOCK OFF” to save the car’s battery.

Selecting the dimmer mode – DIMMER

When you turn on the car headlights, the display automatically dims (Auto Dimmer).

When shipped from the factory, Auto Dimmer mode is activated.

- **DIM OFF:** Cancels Auto Dimmer.
- **DIM ON:** Always dims the display.
- **DIM AUTO:** Activates Auto Dimmer.

Note:

Auto Dimmer equipped for this unit may not work correctly on some vehicles, particularly on those having a control dial for dimming.

In this case, set the dimmer mode to “DIM ON” or “DIM OFF.”

Adjusting the display contrast level – CONTRAST

You can adjust the display contrast level among 1 (dark) to 10 (bright). When shipped from the factory, the display contrast level is set at level 5.

Selecting the scroll mode – SCROLL

You can select the scroll mode for the disc information.

When shipped from the factory, Auto Scroll mode is set to “SCRL ONCE.”

- **SCRL ONCE:** Scrolls only once.
- **SCRL AUTO:** Repeats the scroll (5-second intervals in between).
- **SCRL OFF:** Cancels Auto Scroll.

Selecting the external component to use – EXT INPUT

You can connect the external component to the CD changer jack on the rear using the Line Input Adaptor KS-U57 (not supplied).

To use the external component as the playback source through this unit, you need to select which component – CD changer or external component – to use.

When shipped from the factory, CD changer is selected as the external component.

- **CD CHANGER:** To use the CD changer.
- **LINE INPUT:** To use the external component other than CD changer.

Notes:

- *If the current source is CD changer or external component, this item does not appear.*
- *For connecting the Line Input Adaptor KS-U57 and the external component, refer to the Installation/Connection Manual (separate volume).*

Adjusting the auxiliary input level – AUX ADJ

Adjust the auxiliary input level properly when an external component is connected to the auxiliary input jack.

When shipped from the factory, the auxiliary (AUX) input level is set at level 00.

If the input level of the connected component is not high enough, increase the input level properly. Without adjusting the line input level, you may be surprised at a loud sound when you change the source from the external component to another source.

Turning the demo mode on or off – DEMO MODE

You can turn the demo mode on or off. When shipped from the factory, "DEMO ON" is selected.

- DEMO OFF: Turns the demo mode off.
- DEMO ON: Turns the demo mode on. The demonstration will start automatically if no sound comes in for 3 minutes.

Note:

If the unit has been reset (and the power is on), demonstration will start if no sound comes in for about 15 seconds.

Assigning names to the sources

You can assign names to station frequencies and the external component connected to the AUX input jack.

After assigning a name, it will appear on the display when you select the source.

Sources	Maximum number of the characters
Station frequencies*	Up to 10 characters (up to 32 station frequencies including both FM and AM)
External components ("AUX INPUT" only)	Up to 10 characters

* You cannot assign name to a station frequency stored in the EX (extra) button.

1 Select a source you want to assign a name to.

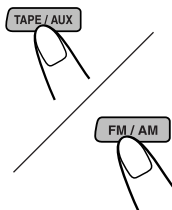

When you select a source, the power automatically comes on. Each time you press the button, the source changes as described on page 7.

2 Press and hold SEL (select) for more than 2 seconds while pressing DISP (display).



(at the same time)

3 Select the character set you want while “” is flashing.

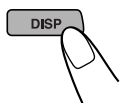

Each time you press the button, the character set changes as follows:

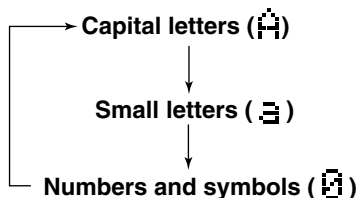

4 Select a character.

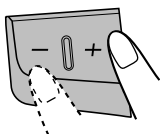

About the available characters, see the right column.

5 Move the cursor to the next (or previous) character position.

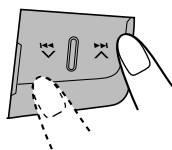

6 Repeat steps 3 to 5 until you finish inputting the name.

7 Finish the procedure while the last selected character is flashing.



To erase the input characters

Press and hold DISP (display) for more than 1 seconds to erase all the characters at a time.

Note:

When you try to assign a name to the 33rd station frequency, “NAME FULL” appears on the display. (In this case, delete unwanted names before assignment.)

Available characters

Capital letters

A	B	C	D	E
F	G	H	I	J
K	L	M	N	O
P	Q	R	S	T
U	V	W	X	Y
Z	space			

Small letters

a	b	c	d	e
f	g	h	i	j
k	l	m	n	o
p	q	r	s	t
u	v	w	x	y
z	space			

Number and symbols

0	1	2	3	4
5	6	7	8	9
!	”	#	\$	%
&	'	()	*
+	,	-	.	/
:	;	<	=	>
?	@	_	`	space

EXTERNAL COMPONENT OPERATIONS

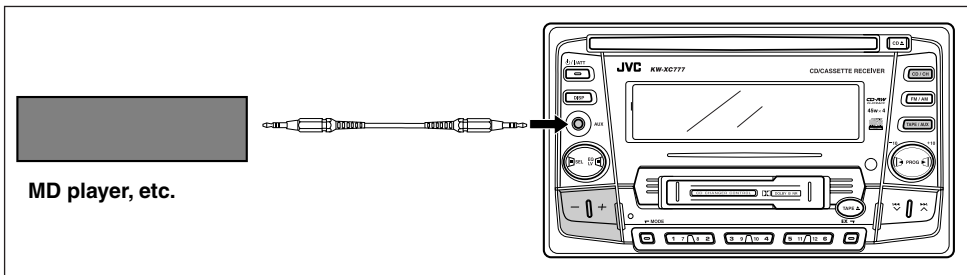

You can connect two external components to this unit.

Connect one to the auxiliary (AUX) input jack on the control panel, and the other to the CD changer jack on the rear.

Preparations:

- For connecting the Line Input Adaptor KS-U57 and the external component, refer to the Installation/Connection Manual (separate volume).
- Before operating the external component connected to the CD changer jack, select the external input correctly. (See “Selecting the external component to use – EXT INPUT” on page 24.)

2 Turn on the connected component and start playing the source.

3 Adjust the volume.

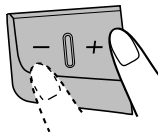

If the input level of the external component connected to the auxiliary (AUX) input jack is not high enough, increase the input level properly.
Without adjusting the input level, you may be surprised at a loud sound when you change the source from the external components to another. (See “Adjusting the auxiliary input level – AUX ADJ” on page 24.)

1 Select the external component.

AUX INPUT: Press TAPE/AUX repeatedly to select the component connected to the AUX jack on the control panel.

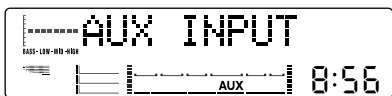

LINE INPUT: Press CD/CH repeatedly to select the component connected to the CD changer jack.

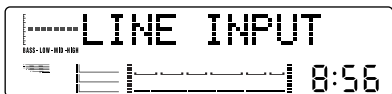

- If “LINE INPUT” does not appear on the display, see page 24 and select the external input (“Selecting the external component to use – EXT INPUT”).



CD CHANGER OPERATIONS

ENGLISH

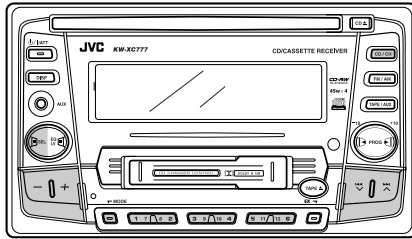

We recommend that you use one of the CH-X series with your unit.

If you have another CD automatic changer, consult your JVC car audio dealer for connections.

- For example, if your CD automatic changer is one of the KD-MK series, you need a cord (KS-U15K) for connecting it to this unit.

Before operating your CD automatic changer:

- Refer also to the Instructions supplied with your CD changer.
- If no discs are in the magazine of the CD changer or the discs are inserted upside down, "NO DISC" will appear on the display. If this happens, remove the magazine and set the discs correctly.
- If "RESET 1 – RESET 8" appears on the display, something is wrong with the connection between this unit and the CD changer. If this happens, check the connection, connect the connecting cord(s) firmly if necessary, then press the reset button of the CD changer.

Playing CDs

Select the CD automatic changer (CD-CH).



Playback starts from the first track of the first disc.

All tracks of all discs are played back.

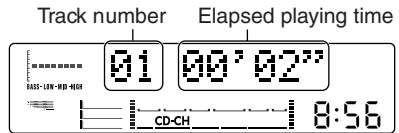

Note on One-Touch Operation:

When you press CD/CH, the power automatically comes on. You do not have to press **⏻/I/ATT** to turn on the power.



To fast-forward or reverse the track

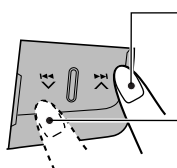

Press and hold **▶▶** **▲** while playing a CD, to fast-forward the track.

Press and hold **◀◀** **▼** while playing a CD, to reverse the track.

To go to the next tracks or the previous tracks

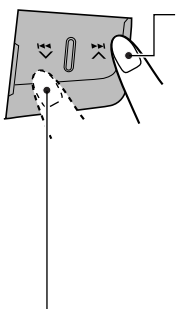

Press **▶▶** **▲** briefly while playing a CD, to go ahead to the beginning of the next track. Each time you press the button consecutively, the beginning of the next tracks is located and played back.

Press **◀◀** **▼** briefly while playing a CD, to go back to the beginning of the current track. Each time you press the button consecutively, the beginning of the previous tracks is located and played back.

To go to a particular disc directly

Press the number button corresponding to the disc number to start its playback (while CD changer is playing).

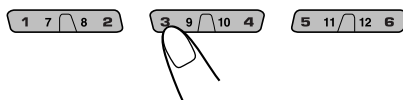

- To select a disc number from 1 – 6: Press 1 (7) – 6 (12) briefly.
- To select a disc number from 7 – 12: Press and hold 1 (7) – 6 (12) for more than 1 second.

Ex.: When disc number 3 is selected.

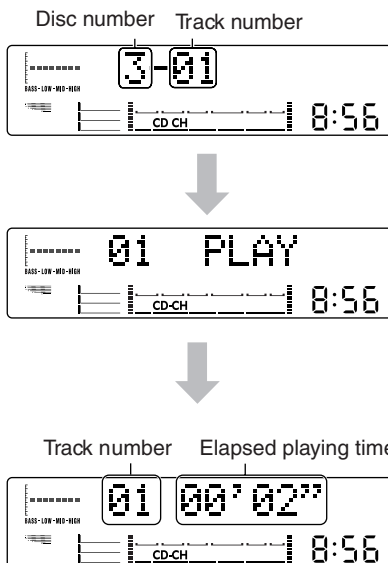



Selecting CD playback modes

To play back tracks repeatedly (Repeat Play)



1 Press MODE repeatedly until "REPEAT" appears.



2 Press SEL. Each time you press the button, CD repeat play mode changes as follows:



Mode	RPT Indicator	Plays repeatedly
REPEAT1 ON	Lights	The current track (or specified track).
REPEAT2 ON	Flashes	All tracks of the current disc (or specified disc).
REPEAT OFF	Goes off	Canceled.

To play back tracks at random (Random Play)

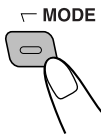

1 Press MODE repeatedly until "RANDOM" appears.



2 Press SEL. Each time you press the button, CD random play mode changes as follows:



Mode	RND Indicator	Plays at random
RANDOM1 ON	Lights	All tracks of the current disc, then the tracks of the next disc, and so on.
RANDOM2 ON	Flashes	All tracks of all discs inserted in the magazine.
RANDOM OFF	Goes off	Canceled.

To play back only intro (Intro scan)

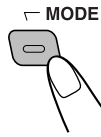

1 Press MODE repeatedly until "INTRO" appears.



2 Press SEL. Each time you press the button, CD intro scan mode changes as follows:



Mode	Indicator	Plays the beginnings (15 seconds)
INTRO1 ON	Track number flashes	Of all tracks on all inserted discs.
INTRO2 ON	Disc number flashes	Of the first track on each inserted disc.
INTRO OFF	None	Canceled.

Track number

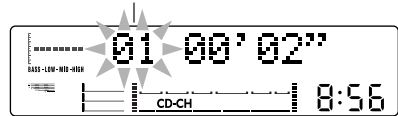

EX.:When "INTRO1 ON" is selected.

Disc number

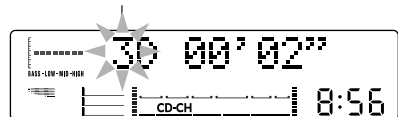

EX.:When "INTRO2 ON" is selected.



Handling cassettes

The cassette deck built in this unit requires very little attention, but you will be able to extend the life of the cassette deck if you follow the instructions below.

To clean the heads

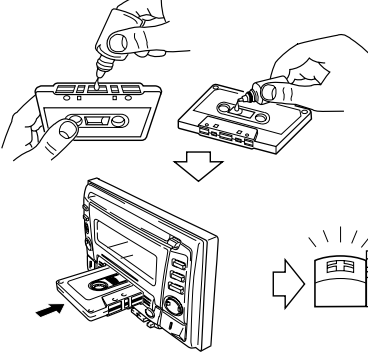

- Clean the heads after every 10 hours of use using a wet-type head cleaning tape (available at an audio store).
When the head becomes dirty, you may realize the following symptoms:
 - Sound quality is reduced.
 - Sound level decreases.
 - Sound drops out.
- Do not play dirty or dusty tapes.
- Do not touch the highly-polished head with any metallic or magnetic tools.

To keep the tape clean

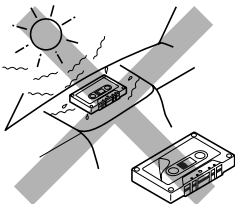

- Always store the tapes in their storage cases after use.
- Do not store tapes in the following places:
 - Subject to direct sunlight
 - With high humidity
 - At extremely hot temperatures

CAUTIONS:

- Do not play the tapes with peeling labels; otherwise, they can damage the unit.
- Tighten tapes to remove slack since loose tape may become entangled with the mechanism.
- Do not leave a cassette in the cassette compartment after use, as the tape may become slack.

The function below is also provided to ensure the longer life of the cassette deck.

Ignition key-off release

When you turn off the ignition key with a cassette in the compartment, the unit automatically releases the tape from its head.



Handling CDs

The CD player built in this unit has been designed to play back the CDs bearing the following marks.



You can also play back your original CD-Rs (Recordable) and CD-RWs (Rewritable) on this receiver.

This unit is not compatible with MP3.

How to handle CDs

When removing a CD from its case, press down the center holder of the case and lift the CD out, holding it by the edges.

- Always hold the CD by the edges. Do not touch its recording surface.

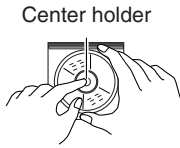

When storing a CD into its case, gently insert the CD around the center holder (with the printed surface facing up).

- Make sure to store CDs into the cases after use.

To keep CDs clean

A dirty CD may not play correctly. If a CD does become dirty, wipe it with a soft cloth in a straight line from center to edge.



To play new CDs

New CDs may have some rough spots around the inner and outer edges.

If such a CD is used, this unit may reject the CD.

To remove these rough spots, rub the edges with a pencil or ball-point pen, etc.

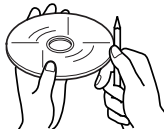

Moisture condensation

Moisture may condense on the lens inside the CD player in the following cases:

- After starting the heater in the car.
- If it becomes very humid inside the car.

Should this occur, the CD player may malfunction. In this case, eject the CD and leave the unit turned on for a few hours until the moisture evaporates.

CAUTIONS:

- Do not insert 8 cm CDs (single CDs) into the loading slot. (Such CDs cannot be ejected.)
- Do not insert any CD of unusual shape — like a heart or flower; otherwise, it will malfunction.
- Do not expose CDs to direct sunlight or any heat source or place them in a place subject to high temperature and humidity. Do not leave them in a car.
- Do not use any solvent (for example, conventional record cleaner, spray, thinner, benzine, etc.) to clean CDs.

When playing a CD-R or CD-RW

You can play back your original CD-Rs or CD-RWs recorded in audio CD format.

- User-edited CD-Rs (Recordable) and CD-RWs (Rewritable) can be played back only if they are already "finalized."
- Before playing back CD-Rs or CD-RWs, read their instructions or cautions carefully.
- Some CD-Rs or CD-RWs may not be played back on this unit because of their disc characteristics, damage or stain on them, or if the player's lens is dirty.
- CD-Rs or CD-RWs are susceptible to high temperatures or high humidity; so do not leave them inside your car.
- CD-RWs may require a longer readout time. (This is caused by the fact that the reflectance of CD-RWs is lower than for regular CDs.)

TROUBLESHOOTING



What appears to be trouble is not always serious. Check the following points before calling a service center.

Symptoms	Causes	Remedies
• CD cannot be played back.	CD is inserted upside down.	Insert the CD correctly.
• CD sound is sometimes interrupted.	You are driving on rough roads.	Stop CD play while driving on rough roads.
	CD is scratched.	Change the CD.
	Connections are incorrect.	Check the cords and connections.
• “NO DISC” appears on the display.	No CD is in the loading slot (or in the magazine.)	Insert CD.
	CD is inserted incorrectly.	Insert it correctly.
• CD can neither be played back nor ejected.	The CD player may function incorrectly.	Press and hold both the ⏪/I/ATT and CD ▲ buttons at the same time for several seconds.
• “EJECT ERR” appears on the display.	The CD was interrupted ejection or insertion.	Press CD ▲ , or press both the ⏪/I/ATT and CD ▲ buttons together to clear the message.
• A cassette tape cannot be inserted.	You have tried to insert a cassette in the wrong way.	Insert the cassette with the exposed tape facing right.
• Cassette tapes become hot.	This is not a malfunction.	_____
• Tape sound is at very low level and sound quality is degraded.	The tape head is dirty.	Clean it with a head cleaning tape.
• Sound is sometimes interrupted.	Connections are not good.	Check the cords and connections.
• Sound cannot be heard from the speakers.	The volume control is turned to the minimum level.	Adjust it to the optimum level.
	Connections are incorrect.	Check the cords and connections.

CONTINUED TO THE NEXT PAGE



Symptoms	Causes	Remedies
<ul style="list-style-type: none"> SSM automatic preset does not work. 	Signals are too weak.	Store stations manually.
<ul style="list-style-type: none"> Static noise while listening to the radio. 	The antenna is not connected firmly.	Connect the antenna firmly.
<ul style="list-style-type: none"> “NO MAGAZINE” appears on the display. 	No magazine is in the CD changer.	Insert the magazine.
<ul style="list-style-type: none"> “RESET 8” appears on the display. 	This unit is not connected to a CD changer correctly.	Connect this unit and the CD changer correctly and press the reset button of the CD changer.
<ul style="list-style-type: none"> “RESET 1–RESET 7” appears on the display. 	_____	Press the reset button of the CD changer.
<ul style="list-style-type: none"> This unit does not work at all. The CD changer does not work at all. 	The built-in microcomputer may function incorrectly due to noise, etc.	Press the reset button on the front panel (see page 2.)
<ul style="list-style-type: none"> CD-R/CD-RW cannot be played back. Tracks cannot be skipped on CD-R/CD-RW. 	CD-R/CD-RW is not finalized.	<ul style="list-style-type: none"> Change a finalized CD-R/CD-RW. Finalize the CD-R/CD-RW with the component which you used for recording.

About mistracking:
Mistracking may result from driving on extremely rough roads. This does not damage the unit and the CD, but will be annoying. We recommend that you stop CD play while driving on such rough roads.

Having TROUBLE with operation?
Please reset your unit
Refer to page of How to reset your unit

SPECIFICATIONS

AUDIO AMPLIFIER SECTION

Maximum Power Output:

Front: 45 W per channel

Rear: 45 W per channel

Continuous Power Output (RMS):

Front: 17 W per channel into 4 Ω ,
40 Hz to 20 000 Hz at no more
than 0.8% total harmonic
distortion.

Rear: 17 W per channel into 4 Ω ,
40 Hz to 20 000 Hz at no more
than 0.8% total harmonic
distortion.

Load Impedance: 4 Ω (4 to 8 Ω allowance)

Equalizer Control Range:

LOW: ± 12 dB (50 Hz, 80 Hz, 120 Hz)

MID: ± 12 dB (700 Hz, 1 kHz, 2 kHz)

HIGH: ± 12 dB (8 kHz, 12 kHz)

Frequency Response: 40 Hz to 20 000 Hz

Signal-to-Noise Ratio: 70 dB

Line-In level/Impedance:

Auxiliary input jack:
(3.5 mm dia. stereo mini jack)

Line-Out Level/Impedance:

2.0 V/20 k Ω load (full scale)

Output Impedance: 1 k Ω

TUNER SECTION

Frequency Range:

FM: 87.5 MHz to 108.0 MHz

AM: 531 kHz to 1 602 kHz

[FM Tuner]

Usable Sensitivity: 11.3 dBf (1.0 μ V/75 Ω)

50 dB Quieting Sensitivity:

16.3 dBf (1.8 μ V/75 Ω)

Alternate Channel Selectivity (400 kHz):

65 dB

Frequency Response: 40 Hz to 15 000 Hz

Stereo Separation: 35 dB

Capture Ratio: 1.5 dB

[AM Tuner]

Sensitivity: 20 μ V

Selectivity: 35 dB

CD PLAYER SECTION

Type: Compact disc player

Signal Detection System: Non-contact optical
pickup (semiconductor laser)

Number of channels: 2 channels (stereo)

Frequency Response: 5 Hz to 20 000 Hz

Dynamic Range: 96 dB

Signal-to-Noise Ratio: 98 dB

Wow and Flutter: Less than measurable limit

CASSETTE DECK SECTION

Wow and Flutter: 0.1 % (WRMS)

Fast-Wind Time: 100 sec. (C-60)

Frequency Response: 30 Hz to 16 000 Hz
(Normal tape)

Signal-to-Noise Ratio: (Normal tape)

Dolby B NR ON: 65 dB

Dolby B NR OFF: 56 dB

Stereo Separation: 40 dB

GENERAL

Power Requirement:

Operating Voltage: DC 14.4 V (11 V to 16 V
allowance)

Grounding System: Negative ground

Allowable Working Temperature:

0°C to +40°C

Dimensions (W x H x D):

Installation Size:

178 mm x 100 mm x 150 mm

Front Panel Size:

170 mm x 96 mm x 20 mm

Mass: 2.2 kg (excluding accessories)

*Design and specifications subject to change without
notice.*

JVC KW-XC777 KW-XC828

LVT0834-002A [U]

Installation/Connection Manual

安裝／連接手冊

คู่มือการติดตั้ง/การต่อสาย

كتيب تعليمات التركيب / التوصيل

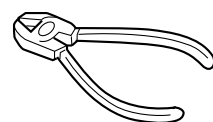
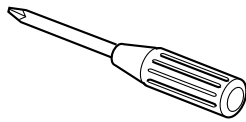

1201MNMMDWJEIN EN, CH,TH,AR

ENGLISH

- This unit is designed to operate on 12 volts DC, NEGATIVE ground electrical systems.

INSTALLATION (IN-DASH MOUNTING)

The following illustration shows a typical installation. However, you should make adjustments corresponding to your specific car. In this case consult the manual included with the installation kit (option).

In some case, depending of the type and the model of your car, it is not possible to install the unit into the center console.

If you have any questions or require information regarding installation kits, consult your JVC car audio dealer or a company supplying kits.

Before installing the unit

- To prevent short circuits, it is recommended to disconnect the battery's negative terminal and make all electrical connections before installing the unit.
- For reason of security, do not install the unit in a place where it may disturb your driving or where there is not enough ventilation space around the unit.
- When the installation position has been determined, confirm that the cords are sufficiently long.
- When mounting the unit, be sure to use the screws provided, as instructed. If other screws are used, there is a possibility that parts could become loose or damaged.
- If you are not sure how to install this unit correctly, consult a JVC car audio dealer or have it installed by a qualified technician.
- When tightening screws or bolts be careful not to pinch any connection cord.

Caution:

To install the mounting brackets to the unit, use only the supplied screws (M5 x 6 mm). If you use any screw longer than 6 mm, the unit can be damaged.

After installing the unit

Check if all the brake lamps, lights, flasher, wiper, etc. work correctly.

中文

- 本機使用直流12V，負極接地的電源系統。

安裝（裝設，固定在儀表板內）

下面的圖解表示了典型的安裝程序。然而，您應當做些適當的調整，以便適應您自己的汽車，請參考配套元件內隨附的使用手冊（選用）。在某些情況下，對於某些類型或型號的汽車，不可能將本機裝入中央控制台。

如果您有問題，或需要有關配套元件的資料，請向JVC汽車音響分銷商或配套元件供應公司詢問。

在安裝本機之前

- 為防止短路，建議在安裝本機之前，斷開電池的負極，並把所有電路都連接好。
- 為安全起見，不要把本機安裝在可能影響您駕駛或通風不足的地方。
- 安裝位置確定之後，請確保有足夠長的連接線。
- 在固定本機時，確保按照提示使用所提供的螺絲釘。若使用其他螺絲釘，零件可能會變鬆或受損。
- 如果您不能確定如何正確地安裝本機，應向JVC汽車音響分銷商請教或請合格的技術人員來安裝。
- 在旋緊螺絲釘或螺栓時，小心不要夾斷任何連接線。

注意：

要把固定托座安裝到本機上，僅能使用所提供的螺絲釘（M5×6mm）。若使用超過6mm長的螺絲釘，會損壞本機。

在安裝本機之後

檢查所有剎車燈、車燈、信號燈、刮水器等的操作是否正常。

ภาษาไทย

- เครื่องนี้ได้รับการออกแบบมาเพื่อใช้งานกับระบบไฟฟ้ากระแสตรง 12 โวลต์ กราวนด์ลบ

การติดตั้ง

(IN-DASH MOUNTING)

ภาพด้านล่างนี้แสดงการติดตั้งโดยทั่วไป อย่างไรก็ตาม คุณควรปรับเปลี่ยนให้เหมาะกับการของคุณ ในกรณีนี้ ให้ดูจากคู่มือที่รวมถึงชุดประกอบการติดตั้ง (อุปกรณ์เสริม)

ในบางกรณี ไม่จำเป็นต้องติดตั้งเครื่องในคอนโซลกลาง ทั้งนี้ ขึ้นอยู่กับชนิดและรุ่นของคุณ

หากคุณมีข้อสงสัยใดๆ หรือต้องการข้อมูลเพิ่มเติมเกี่ยวกับชุดประกอบการติดตั้ง ให้ปรึกษาคู่ค้าตัวแทนจำหน่ายเครื่องเสียงติดรถยนต์ JVC หรือบริษัทที่จัดจำหน่ายชุดประกอบการติดตั้ง

ก่อนการติดตั้งเครื่อง

- เพื่อเป็นการป้องกันไฟฟ้าลัดวงจร เราขอแนะนำให้อดนิ้วมือของแบตเตอรี่ออก และทำการต่อไฟฟ้าทั้งหมดก่อนการติดตั้งเครื่อง
- ด้วยเหตุผลทางด้านความปลอดภัย ห้ามติดตั้งเครื่องในบริเวณที่อาจรบกวนการทำงานของรถ หรือบริเวณที่ไม่มีกระแสระบายอากาศที่พอเพียง
- เมื่อกำหนดตำแหน่งที่จะทำการติดตั้งได้แล้ว ต้องแน่ใจว่าสายไฟมีความยาวที่พอเพียง
- ในขณะที่ติดตั้งเครื่อง ต้องแน่ใจว่าใช้สกรูที่จัดมาให้ตามคำแนะนำ หากมีการใช้สกรูอื่นนอกเหนือจากนี้ อาจเป็นเหตุให้ชิ้นส่วนหลุดหรือเสียหายได้
- หากคุณไม่แน่ใจว่าจะทำการติดตั้งอย่างถูกต้องได้อย่างไร ให้ปรึกษาคู่ค้าตัวแทนจำหน่ายเครื่องเสียงติดรถยนต์ JVC หรือให้ช่างผู้ชำนาญงานเป็นผู้ติดตั้ง
- ในขณะที่ใส่สกรูหรือเกลียวให้แน่น โปรดระมัดระวังไม่ให้หนีบโดนสายที่มีการต่อไว้

ข้อควรระวัง:

การติดตั้งกานยึดติดเข้ากับเครื่อง ให้ใช้เฉพาะสกรูที่จัดไว้ให้เท่านั้น (M5 x 6 มม.)

หากคุณใช้สกรูอื่นที่ยาวกว่า 6 มม. เครื่องอาจเสียหายได้

ภายหลังการติดตั้งเครื่อง

ตรวจสอบว่า ไฟเบรก, ไฟแสงสว่าง, ไฟกระพริบ, ที่ปัดน้ำฝน และอื่นๆ สามารถทำงานได้อย่างถูกต้อง

عربي

- لقد صمم هذا الجهاز ليعمل فقط بواسطة تيار كهربائي مباشر DC، ١٢ فولت، انظمة كهربائية تاربخ سالب.

تركيب الجهاز (داخل-تابلو السيارة)

يبين الرسم التوضيحي التالي طريقة التركيب المثالية. مع ذلك، يجب عليك عمل تعديلات تطابق نوع السيارة التي تمتلكها. في هذه الحالة يرجى الرجوع الي كتيب التعليمات المرفق مع مجموعة أدوات التركيب (اختيارية).

في بعض الحالات، اعتمادا على نوع وموديل سيارتك، ليس من الممكن تركيب الجهاز داخل المكان المخصص للتركيب.

إذا كان هناك استفسارات أو حاجة لمعلومات بخصوص مجموعات أدوات التركيب، يرجى لاستشارة موزع الاجهزة الصوتية للسيارات ماركة JVC أو الشركة الموزعة لمجموعات أدوات التركيب.

قبل تركيب الوحدة

- لمنع حصول تقصير في الدوائر الكهربائية، نوصي بفصل طرف البطارية السالب ثم عمل التوصيلات الكهربائية قبل تركيب الجهاز.
- من أجل الأمان، لا تترك الجهاز في مكان لا يمتلك تهوية كافية حول الجهاز.
- عندما يتم تقرير مكان تركيب الجهاز، تأكد من ان الاسلاك طويلة بشكل كاف.
- عند تركيب الجهاز، تأكد من استعمال البراغي المزودة حسب التعليمات. اذا استعملت براغي غير البراغي المخصصة لهذا الغرض، هنالك احتمال حصول ارتخاء الجهاز أو يمكن ان يحصل ضرر لهذه الاجزاء.
- في حالة عدم معرفتك بكيفية تركيب الجهاز، يرجى لاستشارة موزع الاجهزة الصوتية للسيارات ماركة JVC أو اترك عملية تركيب الجهاز لشخص مختص ومؤهّل لتركيب مثل هذه الاجهزة.
- عند تثبيت البراغي أو امسامير الملولية، لتتبه من اجل عدم قرص او خدش اسلاك التوصيل.

تحذير:

لتركيب كتفبات التركيب على الجهاز، لستعمل فقط البراغي المزودة (M5 × ٦ مم). إذا استعملت براغي اطول من ٦ مم، فانه يمكن ان يحصل ضرر للجهاز.

بعد تركيب الجهاز

تأكد من ان لمبات البريكات والاضواء والغمازات والمساحات، الخ، تشتغل بشكل صحيح.

Parts list for installation and connection

The following parts are provided with this unit. After checking them, please set them correctly.



Flat countersunk screws (M5 x 6 mm)
平埋頭螺絲(M5 × 6)
สกรูหัวเรียบ (M5 x 6 มม.)
براغي راس غطس مستوية (6 × M5) (مم)



Binding screws (M5 x 6 mm)
紧固螺絲(M5 × 6)
สกรูสำหรับยึดติด (M5 x 6 มม.)
براغي ربط (6 × M5) (مم)

用於安裝和連接的零件表

下列零件是隨本機提供的。請點以後，正確的將其裝配。

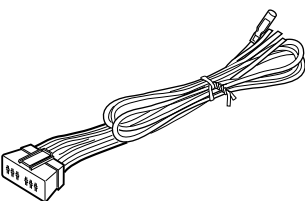

Power cord
電路連接線的配線束
สายไฟ
سلك الطاقة الكهربائية

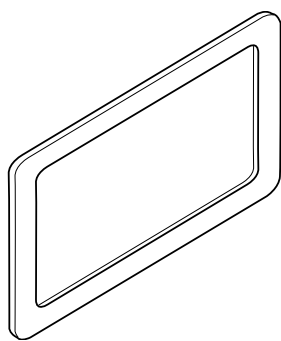

Plate for use with a Nissan car
供尼桑車使用的板
แผ่นสำหรับใช้กับรถยนต์นิสสัน
الصفحة المستعملة مع سيارة نوع نيسان

รายชื่อชิ้นส่วนสำหรับการติดตั้งและการต่อสาย

ชิ้นส่วนต่อไปนี้จะจัดมาพร้อมกับเครื่อง หลังจากทำการตรวจสอบแล้ว กรุณาเก็บเข้าที่เดิม

قائمة اجزاء التركيب والتوصيل

الاجزاء التالية مزودة مع الجهاز. بعد فحص هذه الاجزاء، يرجى تركيبهم بشكل صحيح.

For KW-XC777
用於 KW-XC777
ด้วย KW-XC777

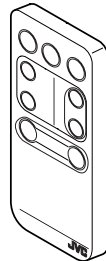

Remote controller
遙控器
รีโมทคอนโทรล
وحدة التحكم عن بعد

For KW-XC828
用於 KW-XC828
ด้วย KW-XC828

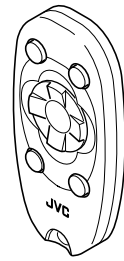

Remote controller
遙控器
รีโมทคอนโทรล
وحدة التحكم عن بعد



CR2025

Batteries
電池
البطاريات

TROUBLESHOOTING

- The fuse blows.**
 - * Are the red and black leads connected correctly?
- Power cannot be turned on.**
 - * Is the yellow lead connected?
- No sound from the speakers.**
 - * Is the speaker output lead short-circuited?
- Sound is distorted.**
 - * Is the speaker output lead grounded?
 - * Are the “-” terminals of L and R speakers grounded in common?
- Unit becomes hot.**
 - * Is the speaker output lead grounded?
 - * Are the “-” terminals of L and R speakers grounded in common?

故障排除

- 保險絲燒斷。
 - * 檢查紅色導線接頭和黑色導線接頭是否連接正確？
- 電源不能接通。
 - * 檢查黃色導線接頭是否接上？
- 揚聲器沒有聲音。
 - * 檢查揚聲器輸出導線接頭是否短路？
 - * 聲音失真。
 - * 檢查揚聲器輸出端子是否接地？
 - * 檢查揚聲器的左（L），右（R）端子的負極（-）是否共同接地？
- 本機發熱。
 - * 檢查揚聲器輸出端子是否接地？
 - * 檢查揚聲器的左（L），右（R）端子的負極（-）是否共同接地？

การแก้ไข้ปัญหา

- ฟิวส์ระเบิด**
 - * ตรวจสอบสีแดงและสีดำถูกต้องหรือไม่
- ไม่สามารถเปิดเครื่องได้**
 - * ตรวจสอบสีเหลืองแล้วหรือไม่
- ไม่มีเสียงออกจากรีโมท**
 - * เกิดไฟฟ้าลัดวงจรที่สายลำโพงหรือไม่
- เสียงเพี้ยน**
 - * ลงกราวนด์สายลำโพงแล้วหรือไม่
 - * ลงกราวนด์ขั้ว “-” ของลำโพง L และ R เหมือนกันหรือไม่
- เครื่องร้อน**
 - * ลงกราวนด์สายลำโพงแล้วหรือไม่
 - * ลงกราวนด์ขั้ว “-” ของลำโพง L และ R เหมือนกันหรือไม่

البحث عن الاعطال والاصلاح

- يحترق الفيوز**
 - * هل السلك الاحمر والاسود موصولة بشكل صحيح؟
 - * لايمكن توصيل الطاقة الكهربائية.
 - * هل السلك الاصفر موصولاً؟
- لايصدر صوت من السماعات.**
 - * هل هنالك تقصير في دائرة سلك خرج السماعة؟
 - * الصوت مشوه.
 - * هل سلك خرج السماعة موصولاً بالارض؟
 - * هل الاطراف السالبة «-» للسماعة اليسرى L واليمنى R موصولة بالارض مع بعض؟
- يسخن الجهاز.**
 - * هل سلك خرج السماعة موصولاً بالارض؟
 - * هل الاطراف السالبة «-» للسماعة اليسرى L واليمنى R موصولة بالارض مع بعض؟

- 1 Remove the audio system originally installed.
Note: Be sure to keep all the screws and parts removed from your car. They are to be used in the future.
- 2 Install the mounting brackets, removed from the car, to this unit.
- 3 Connect the wires (see the diagrams on the reverse side).
- 4 Fix this unit to the car using the screws removed in step 1.

- 1 拆下原先安裝的音響系統。
注意：請保存好從汽車上取下的所有螺絲釘和零件，以備將來使用。
 - 2 將從汽車上拆下的固定托座安裝到本機。
 - 3 將電線連接好（請參閱背面的圖示）。
 - 4 使用上面第一步中拆下的螺絲釘將本機固定到汽車上。
- 下面以丰田牌 (Toyota) 汽車為例對安裝進行說明。欲瞭解更多資料，請向 JVC 汽車音響分銷商詢問。

- 1 ถอดระบบเครื่องเสียงเดิมที่ติดตั้งอยู่ออก
หมายเหตุ: โปรดตรวจสอบให้แน่ใจว่า ได้เก็บสกรูและชิ้นส่วนทั้งหมดที่ถอดออกจากรถของคุณแล้ว ซึ่งชิ้นส่วนเหล่านี้จะนำมาใช้ในอนาคตได้
- 2 ติดตั้งคานยึดติด โดยถอดออกจากรถของคุณ แล้วติดเข้ากับเครื่อง
- 3 ต่อสาย (ดูแผนภาพบนอีกด้านหนึ่งของคู่มือ)
- 4 ยึดเครื่องให้แน่นด้วยสกรูที่ถอดมาจากในขั้นตอนที่ 1

- 1 انزع جهاز الصوت المركب في الاصل.
ملاحظة: تأكد من حفظ البراغي والاجزاء المنزوعة من السيارة.
هناك حاجة لاستعمالها في وقت لاحق.
- 2 ركب كنفيات التركيب المنزوعة من السيارة على هذا الجهاز.
- 3 اوصل الاسلاك بشكل صحيح. (انظر الرسم الموجود على الجانب الخلفي).
- 4 ثبت الوحدة بالسيارة بواسطة استعمال البراغي المنزوعة في الخطوة 1.

The following example shown is for installation in a Toyota.
For more details, consult your JVC car audio dealer.

ตัวอย่างต่อไปนี้แสดงการติดตั้งในรถโตโยต้า
สำหรับรายละเอียดเพิ่มเติม โปรดปรึกษาตัวแทนจำหน่ายเครื่องเสียงติดรถยนต์ JVC

يبين المثال التالي كيفية تركيب الجهاز داخل سيارة نوع تويوتا.
من اجل تفاصيل اكثر، استشر موزع الاجهزة الصوتية للسيارات ماركة JVC.

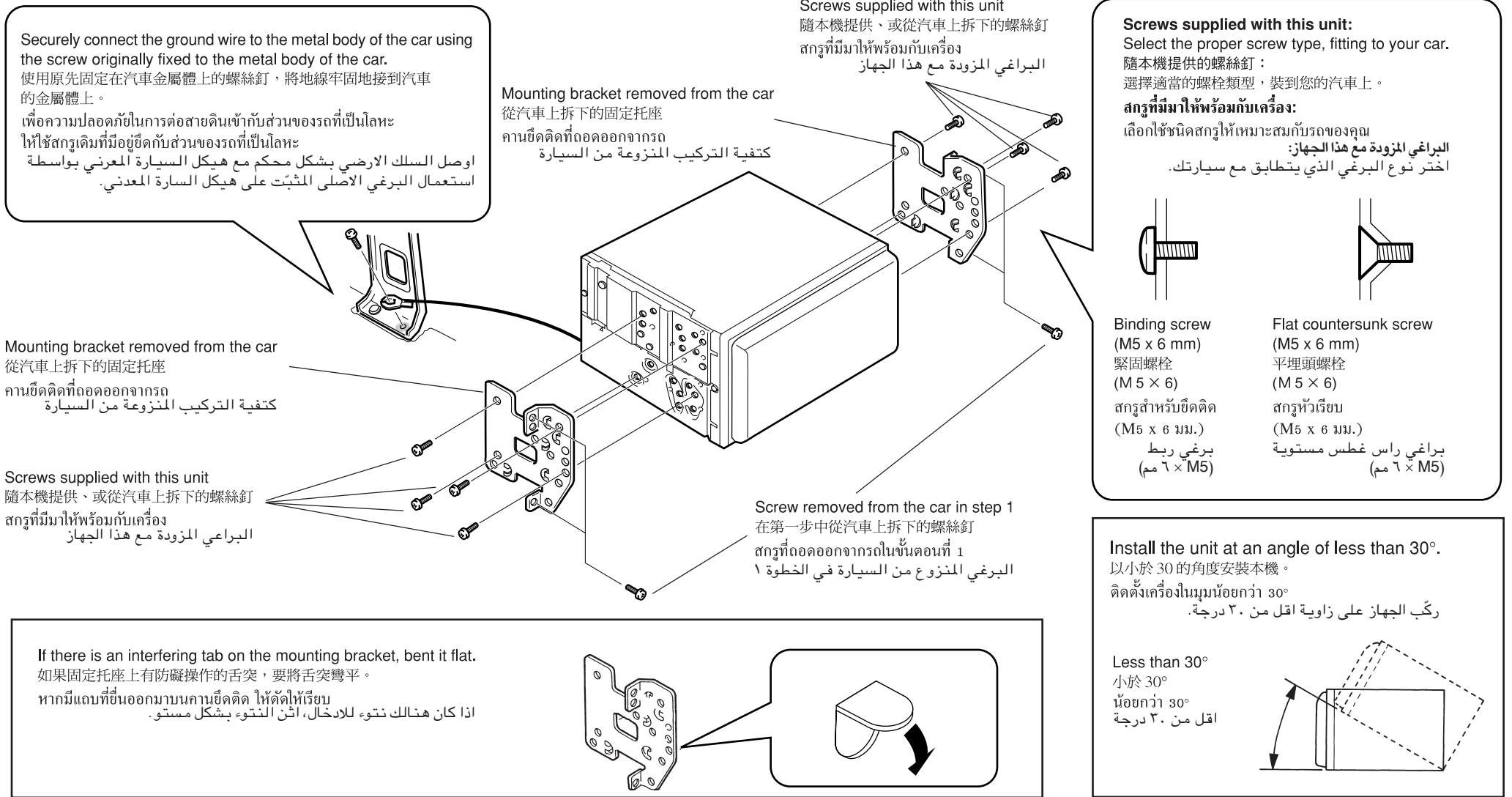

ELECTRICAL CONNECTIONS

電路連接

การเชื่อมต่อด้านไฟฟ้า

التوصيلات الكهربائية

To prevent short circuits, we recommend that you disconnect the battery's negative terminal and make all electrical connections before installing the unit. If you are not sure how to install this unit correctly, have it installed by a qualified technician.

为防止短路，建議在安裝本機之前，斷開電池的負極，並把所有電路都連接好。如果您不能確定如何正確地安裝本機，應請合格的技術人員來安裝。

เพื่อเป็นการป้องกันไฟฟ้าลัดวงจร เราขอแนะนำให้ถอดขั้วลบของแบตเตอรี่ออกและทำการต่อไฟฟ้าทั้งหมด ก่อนการติดตั้งเครื่อง หากคุณไม่แน่ใจว่าจะติดตั้งอย่างถูกต้องได้อย่างไร โปรดปรึกษาตัวแทนจำหน่ายเครื่องเสียงติดรถยนต์ JVC หรือให้ช่างผู้ชำนาญงานเป็นผู้ติดตั้ง

لمنع حدوث تقصير في الدوائر الكهربائية، نوصي بفصل طرف البطارية السالب ثم عمل التوصيلات الكهربائية قبل تركيب الجهاز. في حالة عدم معرفتك بكيفية تركيب الجهاز بشكل صحيح، يرجى ترك عملية تركيب الجهاز لشخص مختص و مؤهل لتركيب مثل هذه الاجهزة.

Note: This unit is designed to operate on 12 volts DC, **NEGATIVE ground electrical systems.** If your vehicle does not have this system, a voltage inverter is required, which can be purchased at JVC car audio dealers.

注意： 本機使用直流 12V、負極接地的電源系統。如果您的車輛沒有這一電源系統，則需要一個電壓變換器，您可以在 JVC 汽車音響分銷商處買到它。

หมายเหตุ: เครื่องนี้ได้รับการออกแบบมาให้ทำงานในระบบไฟฟ้ากระแสตรง 12 โวลต์ กราวนด์ลบ หากยานพาหนะของคุณไม่มีระบบนี้ คุณจำเป็นต้องใช้เครื่องแปลงแรงดันไฟฟ้า ซึ่งสามารถหาซื้อได้ที่ตัวแทนจำหน่ายเครื่องเสียงติดรถยนต์ JVC

ملاحظة لقد صمم هذا الجهاز ليعمل فقط بواسطة تيار كهربائي مباشر DC، ١٢ فولت، أنظمة كهربائية تأريض سالب. في حالة عدم وجود مثل هذا النظام في سيارتك، يجب استخدام محول فولتاج، ويمكن شراء هذا المحول من وكلاء الاجهزة الصوتية للسيارات ماركة JVC.

- Replace the fuse with one of the specified rating. If the fuse blows frequently, consult your JVC car audio dealer.
- If noise is a problem... This unit incorporates a noise filter in the power circuit. However, with some vehicles, clicking or other unwanted noise may occur. If this happens, connect the unit's **rear ground terminal** (see connection diagram) to the car's chassis using shorter and thicker cords, such as copper braiding or gauge wire. If noise still persists, consult your JVC car audio dealer.
- Maximum input of the speakers should be more than 45 watts at the rear and 45 watts at the front, with an impedance of 4 Ω to 8 Ω.
- **Be sure to ground this unit to the car's chassis.**
- The heat sink becomes very hot after use. Be careful not to touch it when removing this unit.

- 把保險絲更換為額定負荷值的保險絲。如果保險絲經常燒壞，請向 JVC 汽車音響分銷商詢問。
- 若出現噪音問題... 本機在電源回路帶有一個噪音濾器。但是，在某些車輛上，會出現喀喀聲或其它噪音。如果發生這類情況，將本機後面的接地端子用短而粗的導線，如編織銅線或標準電纜，連接到汽車底盤上（見電路接線圖）。如果噪音仍然持續存在，請向 JVC 汽車音響分銷商詢問。
- 後置揚聲器的最大輸入功率應大於 45 瓦，前置揚聲器的最大功率 45 瓦，其阻抗的為 4-8 歐姆。
- 務必將本機接地到汽車底盤上。
- 本機使用後，散熱片會很熱。因此，在移出本機時，小心不要觸摸散熱片。

- ใส่ฟิวส์ใหม่ที่มีขนาดตามที่ระบุไว้ หากฟิวส์ระเบิดบ่อยครั้ง ให้ปรึกษาตัวแทนจำหน่ายเครื่องเสียงติดรถยนต์ JVC
- หากมีปัญหานoise... เครื่องนี้มีตัวกรองสัญญาณรบกวนรวมอยู่ในวงจรไฟฟ้า อย่างไรก็ตาม ในบางยานพาหนะ เสียงกริกหรือเสียงที่ไม่ต้องการอื่น ๆ อาจเกิดขึ้นได้ หากเกิดปัญหานี้ขึ้น ให้ต่อ**ขั้วกราวด์ด้านหลังเครื่อง** (ดูแผนภาพการต่อสาย) เข้ากับโครงรถ โดยใช้สายที่หนาและสั้น เช่น ลวดทองแดงแบบเกลียว หรือลวดเกออย่างหนา หากยังคงเกิดสัญญาณรบกวนอยู่ ให้ปรึกษาตัวแทนจำหน่ายเครื่องเสียงติดรถยนต์ JVC
- กำลังไฟฟ้าขาเข้าสูงสุดของลำโพงด้านหลังควรมากกว่า 45 วัตต์ และด้านหน้า 45 วัตต์ โดยมีอิมพีแดนซ์ 4 Ω ถึง 8 Ω
- **ควรแน่ใจว่าได้ต่อกราวด์ของเครื่องไปที่โครงรถแล้ว**
- ฝาระบายความร้อนจะร้อนมากหลังการใช้งาน ควรระมัดระวังไม่ให้สัมผัสกับผิวขณะเคลื่อนย้ายเครื่อง

- الموصوفة. اذا تكرر احتراق الفيوز، يرجى استشارة وكلاء الاجهزة الصوتية للسيارات ماركة JVC. اذا كان الضجيج هو المشكلة...
- يستخدم هذا الجهاز فلتر ضجيج داخل دائرة الطاقة الكهربائية. مع ذلك، في بعض السيارات، يمكن ان يحدث نوع من الطقطقة أو الضجيج غير المرغوب في حالة حدوث مثل ذلك، اوصل طرف التأريض الموجود في خلفية الجهاز (انظر رسم التوصيل) مع هيكل السيارة بواسطة اسبخدام اسلاك اقصر واسمك، مثل سلك النحاس الجدول أو سلك مقياسي. في حالة عدم توقف الطقطقة أو الضجيج، يرجى استشارة وكلاء الاجهزة الصوتية للسيارات ماركة JVC.
- يجب ان يكون الحد الاقصى لدخل السماعات اكثر من 45 واط للسماعات الخلفية و 45 واط للسماعات الامامية، مع ممانعة بين 4 الي 8 اوم.
- تأكد من تأريض الجهاز مع هيكل السيارة.
- تصبح صفيحة خفض الحرارة ساخنة جدا بعد الاستخدام. تأكد من عدم ملامستها عند نزع الجهاز.

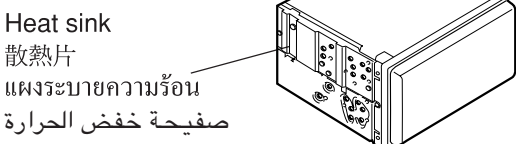

A Typical Connections/ 典型的接線方法/ การเชื่อมต่อแบบทั่วไป/ التوصيلات النموذجية

Before connecting: Check the wiring in the vehicle carefully. Incorrect connection may cause serious damage to this unit.

接線前: 仔細檢查汽車內的線路。不正確的接線會導致本機嚴重損壞。

- 1 Connect the colored leads of the power cord to the car battery, speakers and automatic antenna (if any) in the following sequence.
 - ① Black: ground
 - ② Yellow: to car battery (constant 12V)
 - ③ Red: to an accessory terminal
 - ④ Blue with white stripe (Remote out): to other equipment
 - ⑤ Blue: to automatic power antenna (requires power more than 250 mA.)
 - ⑥ Orange with white stripe: to illumination or small lamp terminal
 - ⑦ Others: to speakers
- 2 Connect the antenna cord.
- 3 Finally connect the wiring harness to the unit.

- 1 按下述順序將配線束各個不同色標的導線接頭分別接至電池，揚聲器和自動昇降天線（如有裝設）：
 - ① 黑色：接地
 - ② 黃色：接至車裝電池（恆定 12V）
 - ③ 紅色：接至保險絲單元內的附屬端子
 - ④ 藍色帶白色條紋（遠端輸出）：往其它設備
 - ⑤ 藍色：往自動電動天線（需要大於 250mA 的電力。）
 - ⑥ 橙色帶有白色條紋：接至照明或小燈泡端子。
 - ⑦ 其它：接至揚聲器
- 2 將連接天線插頭的一端插入本機的天線端子。
- 3 最後，把配線束的插頭插接在本機上。

ก่อนการเชื่อมต่อ : ตรวจสอบการเดินสายไฟในยานพาหนะอย่างระมัดระวัง การต่อสายผิดอาจทำให้เกิดความเสียหายขั้นรุนแรงกับเครื่องได้

- 1 ต่อสายไฟที่เป็นสีเข้ากับแบตเตอรี่รถยนต์, ลำโพง และเสาอากาศแบบอัตโนมัติ (ถ้ามี) ตามลำดับ
 - ① สีดำ: กราวด์
 - ② สีเหลือง: ต่อเข้ากับแบตเตอรี่รถยนต์ (12 โวลต์แบบคงที่)
 - ③ สีแดง: ต่อเข้ากับช่องเสียบเสริม
 - ④ สีน้ำเงินแถบขาว (รีโมทขาออก): ต่อเข้ากับอุปกรณ์อื่น ๆ
 - ⑤ สีน้ำเงิน: ต่อเข้ากับเสาอากาศแบบอัตโนมัติ (เมื่อต้องการกำลังไฟมากกว่า 250 มิลลิแอมป์)
 - ⑥ สีส้มแถบขาว: ต่อเข้ากับหัวหลอดไฟส่องสว่างหรือหลอดไฟขนาดเล็ก
 - ⑦ อื่นๆ: ต่อเข้ากับลำโพง
- 2 ต่อสายเสาอากาศ
- 3 สุดท้าย ต่อสายควบคุมเข้าสู่เครื่อง

قبل البدء بالتوصيل: تأكد من شبكة الاملاك في السيارة بدقة. يمكن ان يسبب التوصيل الخاطيء الى حصول عطل حقيقي للجهاز.

- 1 اوصل الاسلاك الملونة لسلك بطارية السيارة، السماعات والهوائي الاوتوماتيكي (ان وجد) حسب التسلسل التالي.
 - ① السلك الاسود: مع الارض (مع هيكل لسيارة)
 - ② السلك الاصفر: مع بطارية السيارة (ثابت فولت)
 - ③ السلك الاحمر: مع الطرف الاضافي
 - ④ سلك ازرق مخطط بالابيض (خرج التحكم عن بعد): الى جهاز آخر
 - ⑤ ازرق: الى هوائي الطاقة الاوتوماتيكي (يتطلب طاقة اكثر من 200 ميلي امبير.)
 - ⑥ السلك البرتقالي المخطط بالابيض: مع طرف الازياء او اللمبة الصغيرة.
 - ⑦ الاسلاك الاخرى: مع السماعات
- 2 اوصل سلك الهوائي.
- 3 اخيرا، اوصل حامل الاسلاك مع الجهاز.

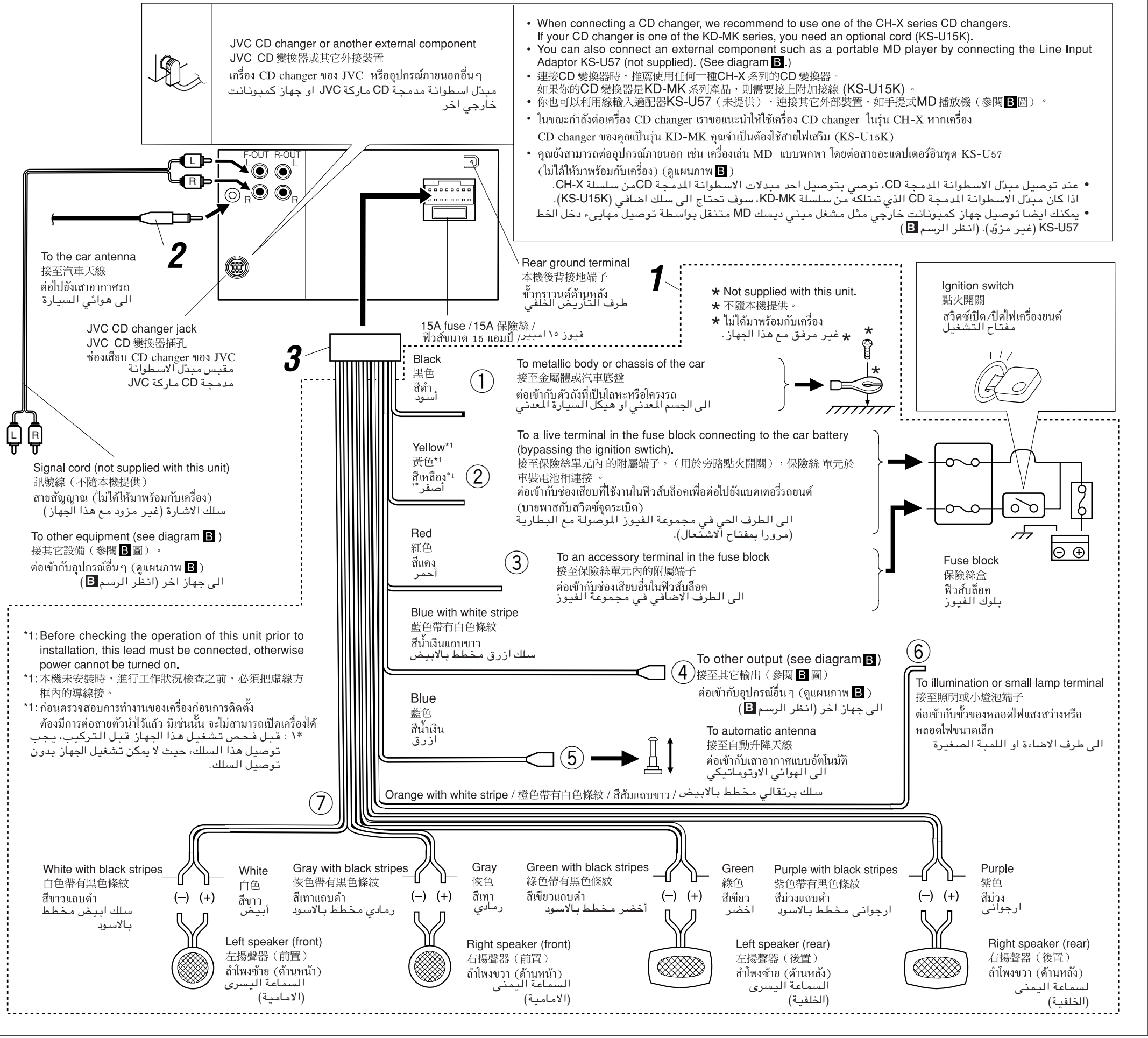

When installing the unit in a Nissan car.
 在尼桑牌(Nissan)汽車內安裝本機時。
 เมื่อทำการติดตั้งในรถยนต์นิสสัน
 عند تركيب الجهاز الجهاز داخل سيارة نوع نيسان.

Plate for use with a Nissan car
 供尼桑牌 (Nissan) 汽車使用的板
 แผ่นสำหรับใช้กับรถยนต์นิสสัน
 الصفيحة المستعملة مع سيارة نوع نيسان

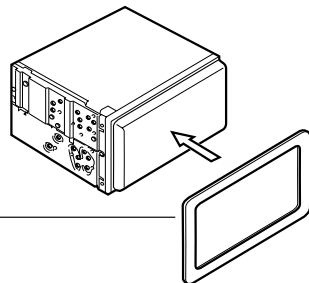

Fix the supplied plate as illustrated.

按照圖示將提供的板固定好。

ยึดแผ่นที่มีมาให้ ดังที่แสดงในภาพ
 ثبت الصفيحة المزودة كما هو مبين في الرسم.

PRECAUTIONS on power supply and speaker connections:

- **DO NOT connect the speaker leads of the power cord to the car battery; otherwise, the unit will be seriously damaged.**
- Connect the black lead (ground), yellow lead (to car battery, constant 12V), and red lead (to an accessory terminal) correctly.
- BEFORE connecting the speaker leads of the power cord to the speakers, check the speaker wiring in your car.
 - If the speaker wiring in your car is as illustrated in Fig. 1 and Fig. 2 below, DO NOT connect the unit using that original speaker wiring. If you do, the unit will be seriously damaged. Redo the speaker wiring so that you can connect the unit to the speakers as illustrated in Fig. 3.
 - If the speaker wiring in your car is as illustrated in Fig. 3, you can connect the unit using the original speaker wiring in your car.
- If you are not sure of the speaker wiring of your car, consult your car dealer.

電源和揚聲器接線注意事項：

- 切勿把揚聲器導線接頭接至電池，否則本機將會嚴重損壞。
- 正確地連接黑色導線接頭(接地)，黃色導線接頭(接車裝電池，恆定 12V)和紅色導線接頭(接至保險絲單元的附屬端子)。
- 在把揚聲器導線接頭接至揚聲器之前，檢查您汽車上的揚聲器線路：
 - 如果您汽車上揚聲器線路象圖 1 和圖 2 所示，不要使用原裝的揚聲器線路。如果使用，本機將會嚴重損壞。要重新連接揚聲器線路，可按圖 3 所示，把本機與揚聲器相連接。
 - 如果您汽車上揚聲器線路象圖 3 所示，可使用原裝的揚聲器線路與本機相連接。
 - 如果您不能確定您汽車上揚聲器線路，請向您的汽車分銷商詢問。

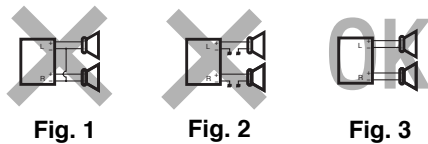

ข้อควรระวังในการต่อสายไฟและลำโพง:

- **ไม่ควรต่อสายไฟของลำโพงเข้ากับแบตเตอรี่รถยนต์** เนื่องจากอาจทำให้เครื่องเสียหายขั้นรุนแรงได้
- ต่อสายสีดำ (สายดิน), สายสีเหลือง (เข้ากับแบตเตอรี่รถยนต์ 12 โวลต์แบบคงที่) และสายสีแดง (เข้ากับช่องเสียบเสริม) ให้ถูกต้อง
- ก่อนการต่อสายไฟของลำโพงเข้ากับลำโพง ให้ตรวจสอบการต่อสายลำโพงภายในรถยนต์ก่อน
 - หากการต่อสายไฟภายในรถยนต์เป็นดังที่แสดงในภาพ 1 และภาพ 2 ด้านล่าง ห้ามต่อเครื่องเข้ากับลำโพงที่ต่อในลักษณะนั้น เนื่องจากอาจทำให้เครื่องเสียหายขั้นรุนแรงได้ ให้ต่อสายลำโพงใหม่ เพื่อให้คุณสามารถต่อเครื่องเข้ากับลำโพงได้ตามที่แสดงในภาพ 3
 - หากการต่อสายไฟภายในรถยนต์เป็นดังที่แสดงในภาพ 3 คุณจะสามารถต่อเครื่องเข้ากับลำโพงที่ต่อในลักษณะนั้นได้
 - หากคุณไม่แน่ใจในการต่อสายไฟภายในรถ ให้ปรึกษากับตัวแทนจำหน่ายของคุณ

تنبيهات حول تزويد الطاقة الكهربائية وتوصيل السماعات:

- لا توصل اسلاك تزويد طاقة السماعات مع بطارية السيارة، لان ذلك يؤدي الى حصول ضرر للسماعات.
- اوصل السلك الاسود (الارضى)، والسلك الاصفر (مع بطارية السيارة، ثابت 12 فولت)، والسلك الاحمر (مع الطرف الاضافي) بشكل صحيح.
- قبل توصيل اسلاك تزويد طاقة السماعات مع السماعات، افحص شبكة اسلاك السماعات داخل سيارتك.
- اذا كانت شبكة اسلاك السماعات داخل سيارتك كما هي مبينة في الشكل 1 والشكل 2 الموجودة في الاسفل، لا توصل الجهاز بواسطة استخدام شبكة اسلاك السماعات الاصلية. اذا تم توصيل الجهاز بهذه الطريقة، سيؤدي ذلك الى حصول ضرر. اعد عمل شبكة اسلاك السماعات بحيث يمكنك توصيل الجهاز مع السماعات كما هو مبين في الشكل 3.
- اذا كانت شبكة اسلاك السماعات داخل سيارتك كما هو مبين في الشكل 3، يمكنك توصيل الجهاز بواسطة استخدام شبكة اسلاك السماعات الاصلية داخل سيارتك.
- في حالة عدم معرفتك بشبكة اسلاك السماعات داخل سيارتك، استشر الوكيل او ذوي الخبرة بهذا الخصوص.

Connecting the leads / 導線接頭的連接 / การต่อสายไฟ / توصيل الاسلاك

Twist the core wires when connecting. 連接前剝掉導線的外皮。
ในการเชื่อมต่อ ให้พันลวดสายไฟเข้าด้วยกัน
ابرص الاسلاك بشكل صحيح قبل التوصيل.

Solder the core wires to connect them securely. 將線芯牢固地焊接在一起。
บัดกรีลวดสายไฟที่ต่อให้แน่น
الحم الاسلاك بشكل صحيح ومحكم بعد التوصيل.

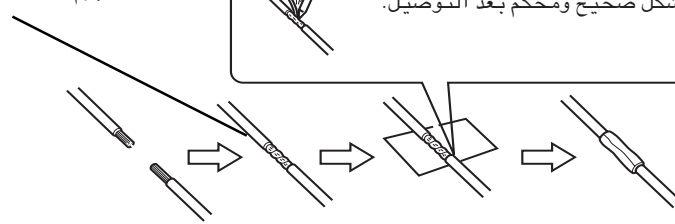

CAUTION / 注意 / ข้อควรระวัง: / تنبيه

- To prevent short-circuit, cover the terminals of the UNUSED leads with insulating tape.
- 連接附加的其他音響設備。
- ในการป้องกันการเกิดไฟลัดวงจร ให้ปิดปลายสายไฟที่ไม่ได้ใช้ด้วยเทปพันสายไฟ
- من اجل منع التصير في الدوائر - الكهربائية، ضع شريط عازل ولاصق على اطراف الاسلاك غير المستعملة.

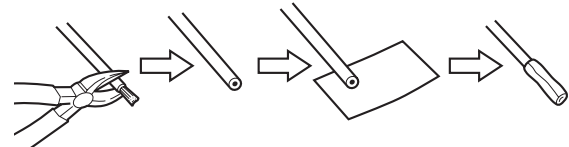

B Connections Adding Other Equipment / 連接附加的其他音響設備 / การเชื่อมต่ออุปกรณ์อื่นเพิ่มเติม / توصيل الاجهزة الاخرى الاضافية

- You can connect an amplifier and other equipment to upgrade your car stereo system.
- For connections, refer also to the instructions supplied for other components.
 - Connect the remote lead (blue with white stripes) to the remote lead of the other equipment so that it can be controlled through this unit.
 - For amplifier only:
 - Connect this unit's line-out terminals to the amplifier's line-in terminals.
 - **Disconnect the speakers from this unit, connect them to the amplifier. Leave the speaker leads of this unit unused. (Cover the terminals of these unused leads with insulating tape, as illustrated above.)**

- 你可以接上放大器和其它設備，以提升你的汽車立體音響系統。
- 連接時，請參閱其它裝置所提供的指南說明。
 - 把遠端到線接頭 (藍色帶有白色條紋) 和遠端的其他音響設備的接頭連接，則可通過本機供電。
 - 只供擴音機用：
 - 連接此裝置的輸出端子到放大器的輸入端子上。
 - 將揚聲器和本機拆開，再連接至擴音機。請不要使用本機的揚聲器導線。(依下圖所示，用絕緣膠布將這些不用的導線接頭遮掩起來。)

- คุณสามารถต่อเครื่องขยายเสียงและอุปกรณ์อื่น ๆ เพื่อเพิ่มประสิทธิภาพระบบเสียงสเตอริโอในรถของคุณได้
- สำหรับการเชื่อมต่อ ให้ดูคำแนะนำที่หามาพร้อมกับอุปกรณ์นั้น ๆ
 - ต่อสายรีโมท (สายสีน้ำเงินแถบขาว) เข้ากับสายรีโมทของอุปกรณ์อื่น เพื่อให้สามารถควบคุมโดยผ่านเครื่องนี้ได้
 - สำหรับเครื่องขยายเสียงเท่านั้น:
 - ต่อสายสัญญาณขาออกของเครื่องเข้ากับสายสัญญาณขาเข้าของเครื่องขยายเสียง
 - ถอดลำโพงออกจากเครื่องนี้ แล้วต่อเข้ากับเครื่องขยายเสียงปล่อยสายลำโพงที่ไม่ได้ใช้ของเครื่องไว้ (ปิดปลายสายไฟที่ไม่ได้ใช้ ด้วยเทปพันสายไฟ ดังที่แสดงในภาพด้านบน)

- يمكنك توصيل مضخم صوت وادوات اخرى وذلك لزيادة مقدرة جهاز ستيريو السيارة
- من اجل التوصيلات، ارجع ايضا الى التعليمات المزودة مع اجهزة الكمبيوتر الاخرى.
 - اوصل سلك التحكم عن بعد (الازرق المخطط بالابيض) مع سلك التحكم عن بعد للجهاز الاخر بحيث يمكن تزويد الطاقة الكهربائية عبر هذا الجهاز.
 - فقط لمضخم الصوت:
 - اوصل اطراف خرج - الخط لهذا الجهاز مع اطراف دخل - الخط لمضخم الصوت.
 - افصل السماعات من هذا الجهاز، ثم اوصل السماعات مع مضخم الصوت. اترك اسلاك سماعات هذا الجهاز بدون استعمال. (ضع شريط لاصق على اطراف الاسلاك غير المستعملة، كما هو موضح في الاعلى.)

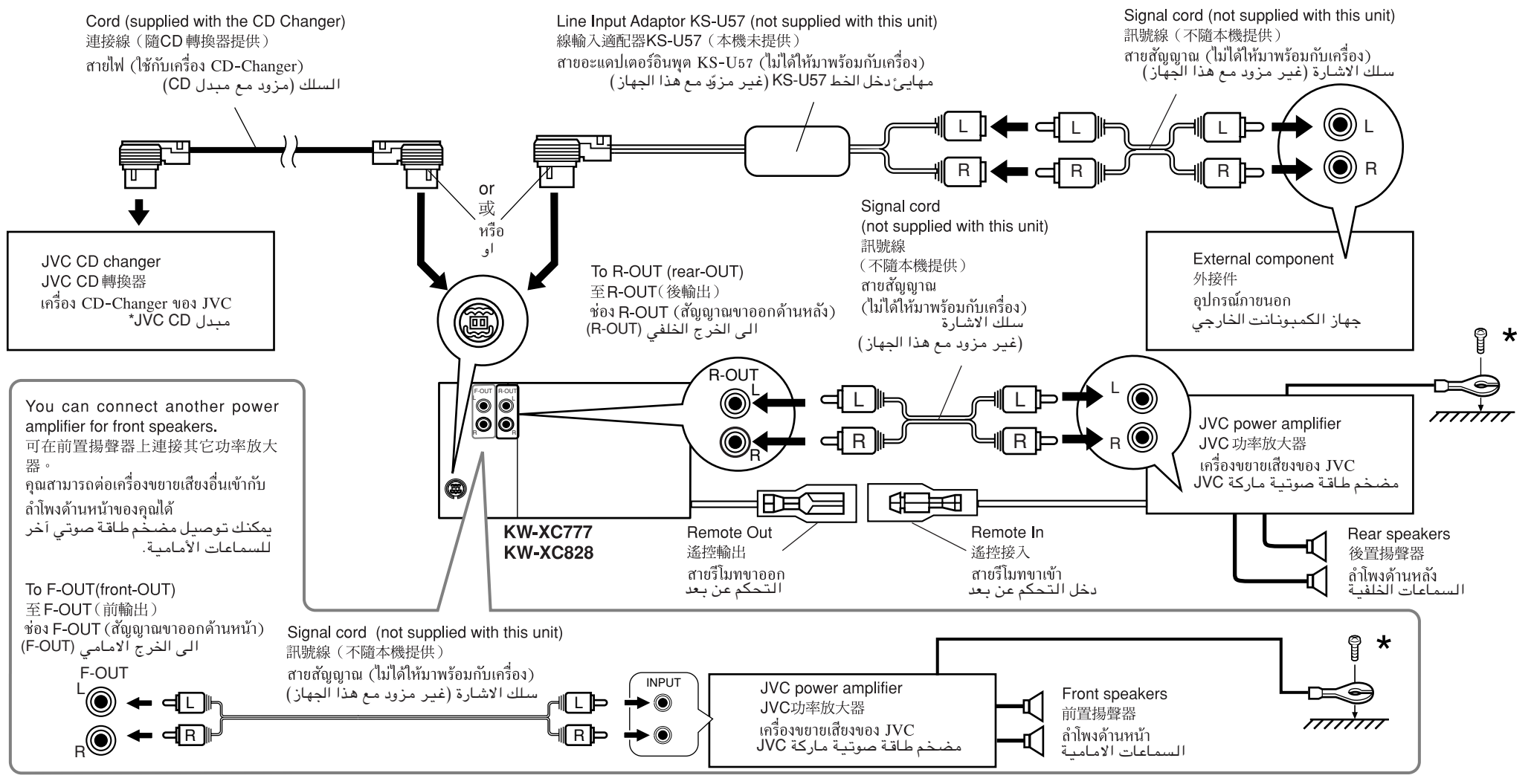

* **Firmly attach the ground wire to the metallic body or to the chasis of car—to the place not coated with paint (if coated with paint, remove the paint before attaching wire). Failure to do so may cause damage to the unit.**

* **請將接地線與汽車的金屬車身或底盤的未塗有油漆的部分 (如果塗有油漆，請在連線之前去除油漆) 牢固地連接一起。如果不按此法連接，可能會損壞本機。**

* **มั่นใจว่า ได้ต่อสายกราวด์เข้ากับตัวถังรถหรือโครงรถแล้ว - บริเวณที่ไม่ได้ถูกทาสีเคลือบ (ถ้ามีการเคลือบสีแล้ว ให้ขัดสีออกก่อนทำการต่อสาย) ถ้าการต่อสายไม่สมบูรณ์จะมีผลเสียหายต่อเครื่อง**

* **قم بتثبيت سلك التاريز بإحكام الى الجسم المعدني او الى شاسيه السيارة الى المكان الغير مطلي بطلاء (اذا كان مطليا بطلاء، قم بإزالة الطلاء قبل تثبيت السلك). الإخفاق في عمل هذا قد يسبب حدوث ضرر بالوحدة.**